



2019 CATALOGUE

ELECTRIC FENCING























Horses	Game	Fish	12 Volt	EconomyLine	Without metal core
Cattle	Chickens	Birds	2-year warranty	PowerLine	With metal core
Sheep	Rabbits	6 Volt	3-year warranty	0 to 500 metres	UV-resistant
Wild boar	Dogs	7.5 Volt	5-year warranty	TurboLine	Stainless steel
Goats	Cats	9 Volt	10-year warranty	Longer than 500 metres	

Maximum output voltage (V)	Voltage with a resistance of 500 Ohm (V)	Voltage with a resistance of 100 Ohm (V)	Stored energy (J)	Maximum impulse energy (J)
Without vegetation (km) (recommended)	Light vegetation (km) (recommended)	A lot of vegetation (km) (recommended)	Fencing surface (ha) (recommended)	Aanbevolen accu (minimaal)
Stroomopname bij 12V(mA)	Stroomopname spaarstand (mA)	Geschikt voor zonnepaneel (minimaal)	Main features	Supply internal/external
Colour	Metres on roll	Voltage at start of fence	500 metres	1000 metres
Resistance (Ohm/metre)	Tensile strength (kg)	ecommended fencing length (m)	High tensile	Medium tensile
Number of stainless steel conductors	Number of copper conductors	Reinforced side wire	Vertical linking	Adapter included

Permanent fence	Adjustable voltage	Chargeable battery	External display	6V battery supply
Portable fencing	Battery life check	Alarm compatible	Includes remote control	9V battery supply
LCD display	Battery-saving options	SMS compatible	Includes fencing monitor	12V battery supply
Output voltage diagram	Energy-saving option	Solar-power supply / solar-power compatible	230V compatible	Includes 6V/12V battery

TABLE OF CONTENTS

New products and special offers	4	
Energizers	8	
Fencing solutions	30	
Batteries	34	
Fencing sets	36	
Security measures and testers	38	
Conductors	41	
Netting	50	
Insulators	55	
Connectors	61	
Gates	63	
Earthing	67	
Reels and tools	68	
Posts	71	
Wolf fencing	78	
Instal and check	89	
Weighing and EID systems	82	
Index	86	





NEW PRODUCTS & SPECIAL OFFERS

THE M5000i - THE NEW POWERHOUSE IN THE MARKET

 **UP TO 100 KM**

The mega-powerful M5000i is the latest addition to the familiar i Series, which represents ultimate power and absolute control.

The ultimate power is achieved by the integrated Adaptive Control®. This provides continuous voltage on the fencing, any time anywhere, with the lowest possible electricity consumption. Energizers from the i Series burn away vegetation and ensure maximum power at the end of the fencing.

NOW WITH FREE APP



Get real-time fence information and alerts from your i series energizer. Buy the Wifi module and get the app for free.

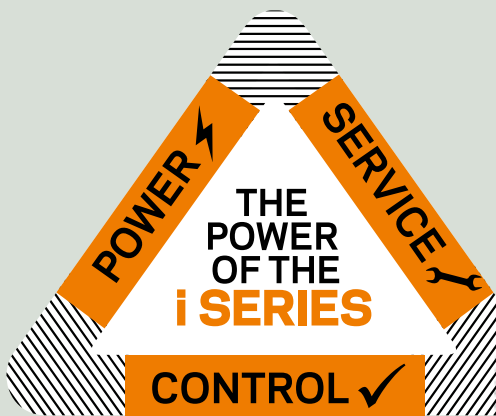



NEW PRODUCTS & SPECIAL OFFERS

THE NEXT GENERATION MULTI-POWER ENERGIZERS!



With the arrival of the MBS range we leave the MB energizers in the market way behind. The MBS energizers are 3-in-1 (mains, battery and solar) and come with the famous Gallagher extras.

The energizers all have the unique battery management system, ensuring that the energizer automatically adjusts to the battery's power level. If the energy in the battery decreases, the pulse adjusts to have current on the fencing for as long as possible. It guarantees that you always have current on your fencing



390314	MBS800	☎ = 1
390307	MBS400	☎ = 1
389318	MBS200	☎ = 1

THE SPECIAL EDITION RANGE EVEN MORE COMPLETE!



"Such power at that price!"



388328	MB300	☎ = 1
388311	MB150	☎ = 1
323329	M650	☎ = 1
323305	M350	☎ = 1



NEW PRODUCTS & SPECIAL OFFERS

AWARD WINNER - THE INSULATED LINE POST

PATENT

Super-efficient fencing solution

The insulated line post with clips is the new solution for permanent fencing. Ideal for leased pasture or difficult to reach pasture. This perfectly insulated post can be positioned and removed by hand without any difficulties. It is just as firmly in the ground as a permanent wooden post, because of the solid foot plate. Due to the fibreglass core and the hdpe coating, it is extremely flexible and gives a little when an animal or something else contacts the fencing. The post really is a complete solution with the corresponding clips that are suitable for all types of Gallagher conductors.

742335	Insulated Line Post 1,50m	☞ = 10
742212	Insulated Line Post 1,35m	☞ = 4
742014	Insulated Line Post 0,95m	☞ = 4

EXTRA ACCESSORIES FOR THE BEST POSSIBLE LINE POST FENCE

747033	TurboLine Line Post tape clip	☞ = 12
744346	Wire clip insulator for Line Post	☞ = 20
717135	Insulated Line Post Dropper	☞ = 10
525013	Line Post Rammer	☞ = 1
530031	Sleeve for Line Post Rammer	☞ = 1
540016	Line Post Pilot	☞ = 1
527017	Line Post Lifter Adapter	☞ = 1
527000	Universal Post Lifter	☞ = 1
106151	Screw-in Tie Down	☞ = 5
006161	Handle for Screw-in Tie Down	☞ = 1



NEW LINE POST DROPPER

The perfect fence with fewer posts
Save 30% on your fence!

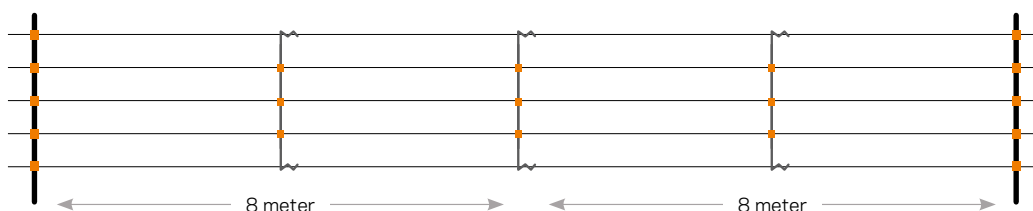

MASSIVE DISCOUNT ON DUOPACKS

M2800i + FREE REMOTE CONTROL

- Powerful mains energizer with 21 Joule stored energy
- External, weatherproof display that serves as on/off switch and as programming panel. Monitors the performance of the fencing.
- Optional expansion with maximum six fencing monitors.



306315 M2800i excl. accessories  = 1

B40 + FREE BATTERY

- The most economical battery energizer
- It is 2.8x more economical than an average 9V energizer because of the night mode/random mode.
- Works on a 9V or 12V battery.
- Suitable for fencing up to 4 km.



386317 B40

 = 1



WHICH GALLAGHER ENERGIZER DO YOU NEED?

If you need to electrify fencing, Gallagher is the place for you! Will you opt for one of our intelligent energizers from the i Series? A battery solution? Maybe a solar energizer is better suited to your situation. Whatever your needs, we can offer the most reliable solution.



MAINS ENERGIZERS

Our mains energizers are ideal for permanent fencing. These energizers do not need a battery and work on 230V.

There are different types of mains energizers for different types of fencing. Gallagher has the most suitable energizer for every type of fencing.

MULTI POWER

The Gallagher Multi Power energizers can be used in every possible way. Would you like to use solar panels, mains or a battery? No problem with these energizers!

SOLAR DEVICES

An energizer that works on solar power is the best choice for remote areas! The battery is charged by sunlight and converts it into electricity. The energizers will continue to run for 3 weeks without any sunlight, do not require maintenance, are environmentally friendly and reliable.

With the new Gallagher Solar range it is even possible to run fencing of up to 30 km on solar power! Absolutely unique in the market! Gallagher through and through!

BATTERY ENERGIZERS

There may be fencing that cannot be connected to the mains and a battery energizer is a better choice in those situations. These energizers only need a battery and no mains. A number of energizers have a battery-saving option to lengthen the lifespan of the battery significantly.

WEEE DIRECTIVE

Our energizers are marked in accordance with the European Directive 2012/19/EU regarding Waste Electrical and Electronical Equipment (WEEE Directive). In case you want to dispose the energizer, you may not treat this device as municipal waste. The device should be delivered to the selling point where you have bought the same or returned without charge to Gallagher Europe. By doing so you contribute to the processing of the device in an appropriate manner and to the prevention of possible harmful consequences for the environment and public health.



i SERIES - 230V

Powerful, intelligent and technically perfect energizers.

With their power, intelligence and technical perfection, the energizers in the i Series are the best in the world! Furthermore, you always receive the best possible service and installation advice from a Gallagher specialist.



ULTIMATE POWER

- Adaptive Control® provides a continuous voltage on the fencing, any time anywhere, with the lowest possible electricity consumption
- Burns away vegetation
- Maximum power, even at the end of the fencing

ABSOLUTE CONTROL

- Extremely practical and easy to operate
- Be warned immediately and anywhere
- Always aware of the state of the fencing with the Energizer Controller®



OPTIMUM SERVICE

- Product and installation advice from the Gallagher specialist
- Now with a 7-year warranty. Check the (promotional) terms and conditions at www.gallagher.eu/warranty
- Global presence with more than 6,000 points of sale in Europe



THE M5000i - THE NEW POWERHOUSE IN THE MARKET

WHAT AN ENERGIZER!"

The mega-powerful M5000i is the latest addition to the familiar i Series, which represents ultimate power and absolute control.

The ultimate power is achieved by the integrated Adaptive Control®. This provides continuous voltage on the fencing, any time anywhere, with the lowest possible electricity consumption. Energizers from the i Series burn away vegetation and ensure maximum power at the end of the fencing.



379326 M5000i

☞ = 1



i Series WiFi Gateway

Fence performance in your pocket! Connect the i Series WiFi Gateway to your existing Gallagher i Series Energizer, install the Dashboard - Fence app on your phone and get real time fence information. The WiFi Module will connect to the port on the back of the i Series Energizer. The controller is then connected directly to the WiFi Gateway.

NEW

NOW WITH FREE APP



567006 i Series WiFi Gateway

☞ = 1



M2800i excl. accessories



The M2800i is an extremely powerful energizer with 21 Joule stored energy, suitable for fences up to 80km. Unique external display enables you to operate and monitor the energizer from a convenient location (up to *50m optional), *3m cable is included. Expandable with remote control and maximum 6 additional fence monitors.

INCLUDED SOLD SEPARATELY

8.0kV

📶

📱

📞

🔔

➤ For more information about the accessories, please visit page 13

306315	M2800i excl. accessories	🔌 = 1
306308	M2800i incl. accessories	🔌 = 1

PROMOTION
FREE REMOTE



The external display enables you to read out information about your fencing from a distance and to operate the energizer.

The energizer adapts to the fencing conditions in order to minimise the energy consumption.

M1800i



The M1800i is a very powerful energizer with 14 Joule stored energy, suitable for fences up to 65km. The external display communicates with the fence. The system is expandable with maximal 6 fence monitors and remote control.

304304	M1800i	🔌 = 1
--------	--------	-------



WOULD YOU LIKE TO KNOW HOW THE SYSTEM WORKS?

Visit www.gallagher.eu/i-series for more information or scan the QR code to view the video.

⋮



SPECIFICATIONS i SERIES



M5000i 379326	9000	9000	8200	19	15	100	60	26	160/400	-	
MB2800i 315331	7000	6400	5400	21	15,5	80	53	20	120/300	•	
MB1800i 315317	7000	7000	5200	14	10	65	43	17	75/190	•	
M2800i 306308	7000	6400	5400	21	14	80	50	20	120/300	-	
M1800i 304304	7000	7000	5200	14	10	65	40	17	75/190	-	

i SERIES ACCESSORIES

- Energizer controller: Shows all your fence performance information in one convenient separate display box that can be placed up to 50m away from the energizer itself.
- Remote controller: to turn the fence on/off anywhere along the fence line. Integrated fault finder functions lead you to the problem in the fence. 'Inquire' function shows energizer display on the Remote Controller from anywhere on the fence. Compatible with M1800i and M2800i only.
- SMS controller: warns you via a text message when the fence voltage gets below a preset alarm level. In addition, the controller sends updates to your mobile phone.
- Alarm controller: to connect a flashlight and / or siren as an alarm.
- Siren/flashlight: these alarm accessories can be connected (single or multiple) to your mains energizers. They will warn you in case there is a problem with your fence.
- Inverter 12V/230V permanent solar: enables you to power all energizers from a 12V source. Ideal for solar projects where i Series technology is required.
- Inverter 12V/230V battery backup: to connect a 12V battery to the I-series as a back-up. If the mains power is lost this device will switch to battery power and take over, so you will always have a safe electric fence.
- SMS remote controller: to switch all mains energizers on and off by calling or texting with your mobile phone. So if you detect a fence failure, you can instantly repair your fence without getting a shock.
- i Series WiFi Gateway: fence performance in your pocket!
- MB series 12V Battery Backup system: provides an automatic battery supply when there is no mains supply to the energizer.

What is included?

i SERIES

Item	MB1000 301303	M1800i 304304	M2800i 306308	M2800i 306315	M5000i 379326	MB2800i 315331	MB1800i 315317
303376 i Series Energizer Controller ☞ = 1	0	•	•	•	•	•	•
507002 i Series Remote Controller ☞ = 1	X	0	•	0	0	0	0
510002 i Series Fence Monitor ☞ = 1	X	0	•	0	0	0	0
579009 i Series Alarm System ☞ = 1	** 0	0	0	0	0	0	0
567600 i Series SMS Controller ☞ = 1	0	0	0	0	0	0	0
005215 Siren ☞ = 1	** 0*	0*	0*	0*	0*	0*	0*
005208 Flashlight ☞ = 1	** 0*	0*	0*	0*	0*	0*	0*
069392 Inverter 12V/230V ☞ = 1	** 0	0	0	0	0	0	0
069408 Inverter 12V/230V ☞ = 1	** 0	0	0	0	0	0	0
557063 SMS remote control (GSM) ☞ = 1	** 0	0	0	0	0	0	0
567006 i Series WiFi Gateway ☞ = 1	0	0	0	0	0	0	0
582108 MB series 12V Battery Backup system ☞ = 1	** 0	x	x	x	x	0	0

* Only together with 579009

** Also compatible with other 230V energizers

• Included

0 Optional

X Not possible



THE SPECIAL EDITION RANGE EVEN MORE COMPLETE!

Such power at that price!



HIGH POWER ⚡ LOW PRICE



M350, M550 AND M650

323305, 323312 and 323329

- Pure power at a competitive price;
- Built-in lightning conductor;
- LED indicator in ON mode.
- Enough power for fencing of up to 12km/28km.

M950 AND M1400

324302 and 324319

- Pure power at a competitive price;
- Built-in lightning conductor;
- Battery status clear with LED indicator;
- Enough power for fencing of up to 30km/38km.



MB150 AND MB300

388311 and 388328

- Pure power at a competitive price;
- Multi-Power energizer - suitable for mains and 12V battery;
- Built-in lightning conductor;
- Battery status clear with LED indicator;
- Includes a set of connecting cables.
- Enough power for fencing of up to 6km/12km.

323305	M350	☎=1
323312	M550	☎=1
323329	M650	☎=1
324302	M950	☎=1
324319	M1400	☎=1
388311	MB150	☎=1
388328	MB300	☎=1

230V

The Gallagher mains energizers are ideal for permanent fencing; they are top quality and offer plenty of power. All you need to do is connect them to the mains. Gallagher has a suitable solution for every type of fencing.



M1400

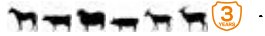

The M1400 is a sturdy mains energiser, suitable for fencing of up to 55 km. The energiser has a built-in lightning conductor and a LED bar on the front that shows the voltage of the fencing.



324319 M1400

⚡ = 1

M950



With the mains energiser M950 you can supply power to fencing of up to 42 km. The energizer has a LED bar on the front that shows the energizer's performance. It also has a built-in lightning conductor.



324302 M950

⚡ = 1



M650



New in the special edition range, the M650 energizer. The M650 can power fencing of up to 40 km. The energizer has a built-in lightning conductor and a power LED that shows whether the energizer is on or off. The sturdy housing makes this a super energizer at a competitive price.



323329 M650

☞ = 1

M550

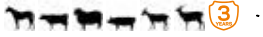

A mains energizer with a fantastic price/quality ratio. The M550 has enough power for fencing of up to 35 km. The energizer has a simple, but sturdy housing with a power LED and is fitted with a lightning conductor.



323312 M550

☞ = 1

M350



The smallest mains energizer in the Special edition series. This energizer has a fantastic price/quality ratio. The M350 has enough power for fencing of up to 28 km. The energizer has sturdy housing with a power LED and is fitted with a lightning conductor.



323305 M350

☞ = 1



M160



Easy to operate mains energizer for shorter runs of fencing up to 9 km. Very easy to install. With integrated lightning protection.



384306 M160

☎ = 1

M120



Easy to operate mains equipment for shorter runs of fencing up to 8 km. Very easy to install using the wall clip supplied. With integrated lightning protection.



033333 M120

☎ = 1

M50



Easy to operate mains equipment for short runs of fencing, especially suitable for domestic pets. Very easy to install using the wall clip supplied. With integrated lightning protection.



038332 M50

☎ = 1

SPECIFICATIONS 230V ENERGIZERS



	max. energy	500 Ω	100 Ω	(J)	max. current	km	km	km	ha	
M1400 324319	7700	7700	4300	12	7,7	55	34	14	56/140	
M950 324302	7700	7700	3800	9	6,2	42	31	11	38/95	
M650 323329	9200	7100	3600	6,9	4,5	40	28	10	26/65	
M550 323312	9200	7000	3500	5,8	3,9	35	25	9	22/55	
M350 323305	8700	6300	3200	3,9	2,7	28	12	7	14/35	
M160 384306	7700	4600	1600	1,6	0,6	9	3,5	1,8	6/14	
M120 033333	7000	3800	1300	1,2	0,65	8	3	1,2	4/10	
M50 038332	7000	3300	1100	0,5	0,3	4	2	1	2/5	

Use the Energizers calculator on www.gallagher.eu to calculate which energizer is best suited to your situation.





MULTI POWER

When it comes to flexibility, the Multi-Power energizers are the ideal choice for electric fencing. You can either just use the battery or to combine it with a solar panel to charge the battery. MultiPower energizers can also be connected to the mains by means of the optional mains adapter 12 V/230 V.

MULTI POWER SWITCHES BETWEEN 12V-230V / SOLAR ENERGY



MBS800



The MBS800 is the most powerful 3-in-1 multi-power energizer. This energizer can be used with 230V, a 12V battery or a solar panel. You can select your source of power with a button with various settings. The energizer is suitable for fencing of up to 40 km and has a battery control indicator. Includes a set of cables.





MBS400



The MBS400 is a 3-in-1 multi-power energizer. Suitable for use with a solar panel, 12V battery or on 230V. You can select your source of power with a button with various settings. The energizer is suitable for fencing of up to 30 km, it has a battery control function and a built-in lightning conductor. Includes a set of connecting cables.



390307 MBS400

☞ = 1

MBS200



The MBS200 is a 3-in-1 multi-power energizer. Suitable for use with a solar panel, 12V battery or on 230V. The energizer is easy to move and suitable for fencing of up to 20 km. It has a farm-proof design, battery control function and a built-in lightning conductor. Includes a set of connecting cables.



389318 MBS200

☞ = 1

Solar kit + Bracket



The solar-panel kit provides a solution for converting MBS energisers into solar-powered energisers. Due to its intelligent design, the bracket can be attached to a wooden or a steel post.



495415 40W Solarpanel + Bracket

☞ = 1

Solar kit + Bracket



The solar-panel kit provides a solution for converting MBS energisers into solar-powered energisers. Due to its intelligent design, the bracket can be attached to a wooden or a steel post.



495217 20W Solarpanel + Bracket

☞ = 1



MB300



The MB300 is a multi-power energizer for fences of up to 25 km. The energizer works on 230V and with a 12V battery. The design means the energizer is easy to move and it can be fixed in various ways, to a wall for example. The energizer is supplied with a set of cables.



388328 MB300

☎ = 1

MB150



The MB150 is a multi-power energizer that works on 230V, but it can also be used with a 12V battery. The energizer is easy to move, because of its unique design. The LED shows the status of the battery when it is connected. The energizer can power fencing of up to 15 km and comes with a set of connecting cables.



388311 MB150

☎ = 1

MB2800i



The most powerful and most intelligent battery energizer in the market - that is the MB2800i. This strong energizer provides enough power for fencing of up to 80 km. This energizer can be used with a battery and a solar panel or it can be connected to the mains. It is versatile, with absolute control over your fencing! The external displays makes it easy to read the performance of your energizer, and together with the optional accessories you can expand this control even further.



315331 MB2800i

☎ = 1

9.00

MB1800i



The flexibility of a Multi-power energizer, combined with the power and intelligence of the i Series. This intelligent energiser can be used with a battery or it can be connected to the mains. The energizer is suitable for fencing of up to 65 km and provides insight into the fencing's performance with the supplied external display. There are many accessories that can be used to expand your energizer and to have absolute control over your fencing.



315317 MB1800i

☎ = 1

MB1000



The MB1000 is our Multi Power energiser for fences of up to 45 km. This energiser is a strong time-delayed battery energiser with a battery. The MB1000 will integrate well with a solar solution. An optional 230V/15V grid adapter is available to power the product from mains supply if required. (item no 401324)



301303 MB1000

☎ = 1

401324 For MBi series Energizers

☎ = 1

MB series 12V Battery Backup system



The Gallagher battery back-up provides an automatic battery supply when there is no mains supply to the energizer. The back-up is easy to install and compatible with all i-series and MB/MBS energisers.



582108 12V Battery Backup system

☎ = 1



SPECIFICATIONS MULTI POWER



MBS800 390314	9200	6680	2670	7,5	4,9	40	-	10	32/80	Optima S5,5L	-	446	-	60W	•		
MBS400 390307	9100	6400	2340	4	3,1	30	-	8	16/40	Optima S5,5L	-	257	-	40W	•		
MBS200 389318	9000	5800	2315	2	1,5	20	-	5	8/20	Optima S5,5L	-	176	-	20W	•		
MB300 388328	9100	5880	2420	2,65	2	25	-	6	12/30	Optima R3,7L	-	217	-	30W	•		
MB150 388311	8580	5540	2230	1,5	1,16	15	-	4	6/15	Optima R3,7L	-	195	-	20W	•		
MB2800i 315331	7000	6400	5400	21	15,5	80	53	20	120/300	3x Optima S5,5L	730	-	-	2x60W	•		
MB1800i 315317	7000	7000	5200	14	10	65	43	17	75/190	2x Optima S5,5L	550	-	-	2x60W	•		
MB1000 301303	8000	7800	3800	10	6	45	28	11	40/100	Optima S5,5L	510	-	-	2x60W	•		

IMPORTANT! Before you connect the mains adapter to your MultiPower energizer, you need to disconnect the battery first! Never connect to the mains when the battery is also connected!

ADAPTER TYPE 1

Connect the cable as shown

ADAPTER TYPE 2

Cable set

230V adapter

Connection



SOLAR

Are you looking for an energizer that provides free energy and is environmentally friendly too? Go for solar! The Gallagher solar range consists of energizers with an integrated solar panel. We also have individual solar panels and batteries that can be used with 9V/12V energizers.

S400 incl. batteries



The S400 is the powerhouse of solar energisers. With the S400 you can power fencing of up to 30 km without any difficulties. The S400 has a powerful 40W solar panel. With the built-in smart battery management, the energiser works several weeks without daylight. It ensures you have current on your fencing all year round.



361307	S400 incl. batteries	☞ = 1
730003	Stand for S200 and S400	☞ = 1
033931	12V 7,2Ah Battery S200, S400	☞ = 1

S200 incl. batteries



The S200 is a portable solar energiser, suitable for fencing of up to 20 km. The S200 has a functional 20W solar panel. The energiser is easy to install and still puts enough current on the fencing after several weeks without daylight.



360300	S200 incl. batteries	☞ = 1
730003	Stand for S200 and S400	☞ = 1
033931	12V 7,2Ah Battery S200, S400	☞ = 1



S100 incl. battery



With the S100 it is easy to place fencing of up to 10 km without you having to charge the battery. This powerful energiser works on solar power, is quick to install and easy to transport. No more hassle with empty batteries, with the S100 you still have power, even after 3 weeks without daylight.



346304	S100 incl. battery	☞ = 1
000442	Battery S100	☞ = 1

S40 incl. battery



The S40 is the ultimate energiser for fencing of up to 5 km. The energiser is quick to install and easy to transport. The energiser will work for 3 weeks without daylight and has a built-in lightning conductor. This makes the S40 an excellent alternative to a battery-operated system.



345307	S40 incl. battery	☞ = 1
000459	6V 10Ah Battery S40	☞ = 1

S20 incl. battery and mount



Do you regularly move your animals to a different pasture? Your fencing is less than 3 km long? The S20 is your ideal choice. This energiser works on solar power and is environmentally friendly and maintenance free. It is also easy to move and fall-resistant.



341323	S20 incl. battery and mount	☞ = 1
075188	6V 4Ah Battery S10, S16, S20	☞ = 1

S16 incl. battery



The S16 is the ultimate portable Energizer solution, storing 0.1 J and capable of powering up to 1 mile/1,5km or 0.5 hectare of Multi-wire fence. The Energizer comes complete with a rechargeable battery and solar panel. The S16 is quick and easy to install and convenient to transport. This robust and highly portable unit makes a great alternative to battery-powered systems.



341316	S16 incl. battery	☞ = 1
075188	6V 4Ah Battery S10, S16, S20	☞ = 1

S10 incl. battery



The S10 is the latest solar energiser suitable for the hobby market and short fences <1 km>. The energiser is quick and easy to install and will work for up to 3 weeks without daylight and is capable to power through the harshest winters. The S10 is super tough making it drop resistant and waterproof. The Energizer comes complete with a rechargeable battery and solar panel.



341309	S10 incl. battery	☞ = 1
075188	6V 4Ah Battery S10, S16, S20	☞ = 1

Mount Solar post S10, S16, S20



Install the S10, S16 or S20 energiser on a Gallagher Ring Top Post using the Post Mount.



571102	Mount Solar post S10, S16, S20	☞ = 1
---------------	--------------------------------	-------



SPECIFICATIONS SOLAR ENERGIZERS

S400 361307	9600	6000	2400	4,0	3,1	30	16	7	16/40	2x 12V-7.2Ah	12/321	40W		
S200 360300	9600	4000	1200	2,0	1,6	20	10	5	8/20	2x 12V-7.2Ah	12/171	20W		
S100 346304	9600	3600	1000	1,0	0,74	10	5	3	4/10	12V-7.2Ah	12/43	7W		
S40 345307	7900	2300	800	0,40	0,26	5	3	1,5	5	6V-10Ah	6/46	4W		
S20 341323	7900	2100	500	0,20	0,14	3	1,5	1	1,2/3	6V-4Ah	6/29	1,5W		
S16 341316	7000	2000	500	0,16	0,12	1,5	0,8	0,5	0,8/2	6V-4Ah	6/17	1,5W		
S10 341309	7000	1600	500	0,10	0,08	1	0,5	0,3	0,5/1,3	6V-4Ah	6/14	1,5W		

S230



The ultimate solar combination: the trusted B200 with 1.45 Joules stored energy (for fences up to 20km), powered by an Optima Yellow top, that is charged by a 30W solar panel. For a reliable and maintenance free operation for many years.



060870 S230 (B200+30W+Optima 3,7L) = 1

S220



The ultimate solar combination: the trusted B200 with 1.45 Joules stored energy (for fences up to 20km), powered by an Optima Yellow top, that is charged by a 20W solar panel. For a reliable and maintenance free operation for many years.



061556 S220 (B200+20W+Optima 2,7L) = 1

Solar assist kit



Solar assist kits 4W & 6W fits within a minute, 4W with the B40 & B50 energizers and the 6W with the B100, B200 & B300 energizers. It doesn't charge the battery but doubles battery life.



068593 4W assist kit for B40/B50 = 1

068609 6W assist kit = 1



SPECIFICATIONS SOLAR KITS

	Schrikdraadapparaat (bijgeleverd)	Accu (bijgeleverd)	Zonnepaneel / Watt (bijgeleverd)	Beugel voor zonnepaneel	Draagbox / Solardraagbox
S230 060870	B200	Optima YT R3,7L	30W	Included	Integrated
S220 061556	B200	Optima YT S2,7L	20W	Included	Integrated



SOLAR PANELS

- Gallagher provides top-quality, tested solar panels with a 2-year warranty on all modules.
- Solar power is environmentally friendly and an increasingly popular economical energy provider.
- All solar panels have a controller that protects the battery against overcharging.
- The range is completed with galvanised brackets, bolts and clamps.
- All solar panels have polycrystalline cells for maximum energy yield.
- Solar panels can be used with mains energizers if you use a converter (item no 069392)..

Solar panels in combination with battery energizers extend the lifespan of your battery

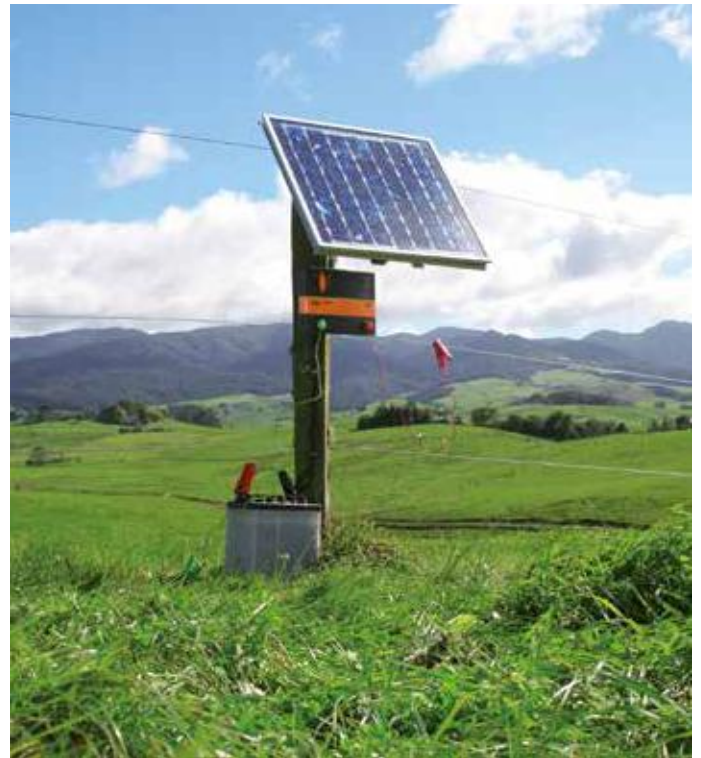

Solar panel



Polycrystalline high-performance solar module with optimised low-light and temperature features. Shock-resistant and hardened solar glass with self-cleaning surface and sturdy aluminium frame. Complete with power cable. Very easy fitting. More than 20 year service life.



041701	10 Watt incl. 2A regulator	☞ = 1
041732	20 Watt incl. 2A regulator	☞ = 1
041725	30 Watt incl. 10A regulator	☞ = 1
027897	50 Watt incl. 10A regulator	☞ = 1
041718	60 Watt incl. 10A regulator	☞ = 1

Solar panel bracket

Bracket for mounting a 10W, 20W or 30W GE Solarpanel to a B100, B200 or B300 Energizer.



068709	Bracket for B100/B200/B300	☞ = 1
069774	Bracket for 10/20/30W	☞ = 1
069781	Bracket for 50/60W Solar panel	☞ = 1

Solar panel regulator



Part.nr. 068838 2A regulator for 10W and 20W Solarpanel.
Part.nr. 068845 10A regulator for 30W, 50W and 60W Solarpanel.



068838	2A Regulator for 10/20W Solar panel	☞ = 1
068845	10A Regulator for >30W Solar panels	☞ = 1



SPECIFICATIONS SOLAR PANELS

	Length x width x height (mm)	Weight (kg)	Nominal peak power (Wp)	Voltage at nominal power (Vmp)	Current at nominal power (Imp)	Voltage at open circuit (Voc)	Short-circuit current (Isc)	Operating temperature	Maximum system voltage (DC)	Solar cell	Suitable for	Min. recommended 12V battery / Ah	High-efficiency crystalline cells	Aluminium frame	Bracket for post, wall, theft-proof cabinet assembly. (not included)	Bracket for fitting on battery box B100, B200, B300 (not included)	Controller	Battery connection cable (m) included	Includes crocodile clip
10 Watt 041701	340 x 280 x 17	1,1	10Watt	17.3	0.59A	21.6	0.65A	-40C til +85C	1000V	Poly-crystalline	B20, B35, B40, B50, B80, B80, B100	25/65	•	•	069774	068709	2Amp	2	•
20 Watt 041732	340 x 450 x 25	1,8	20Watt	17.5	1.15A	22.0	1.27A	-40C til +85C	1000V	Poly-crystalline	B60, B80, B100, B180, B200, MB150	65/85	•	•	069774	068709	2Amp	2	•
30 Watt 041725	340 x 635 x 25	2,5	30Watt	17.5	1.72A	22.0	1.90A	-40C til +85C	1000V	Poly-crystalline	B200, B280, B300, MB300	85	•	•	069774	068709	10Amp	3	•
50 Watt 027897	660 x 530 x 35	4,2	50Watt	17.5	2.86A	22.0	3.17A	-40C til +85C	1000V	Poly-crystalline	B280, B300, MB300	105	•	•	069781		10Amp	3	•
60 Watt 041718	660 x 630 x 35	5,0	60Watt	17.5	3.43A	22.0	3.80A	-40C til +85C	1000V	Poly-crystalline	MB1000, MBS800	105	•	•	069781		10Amp	3	•

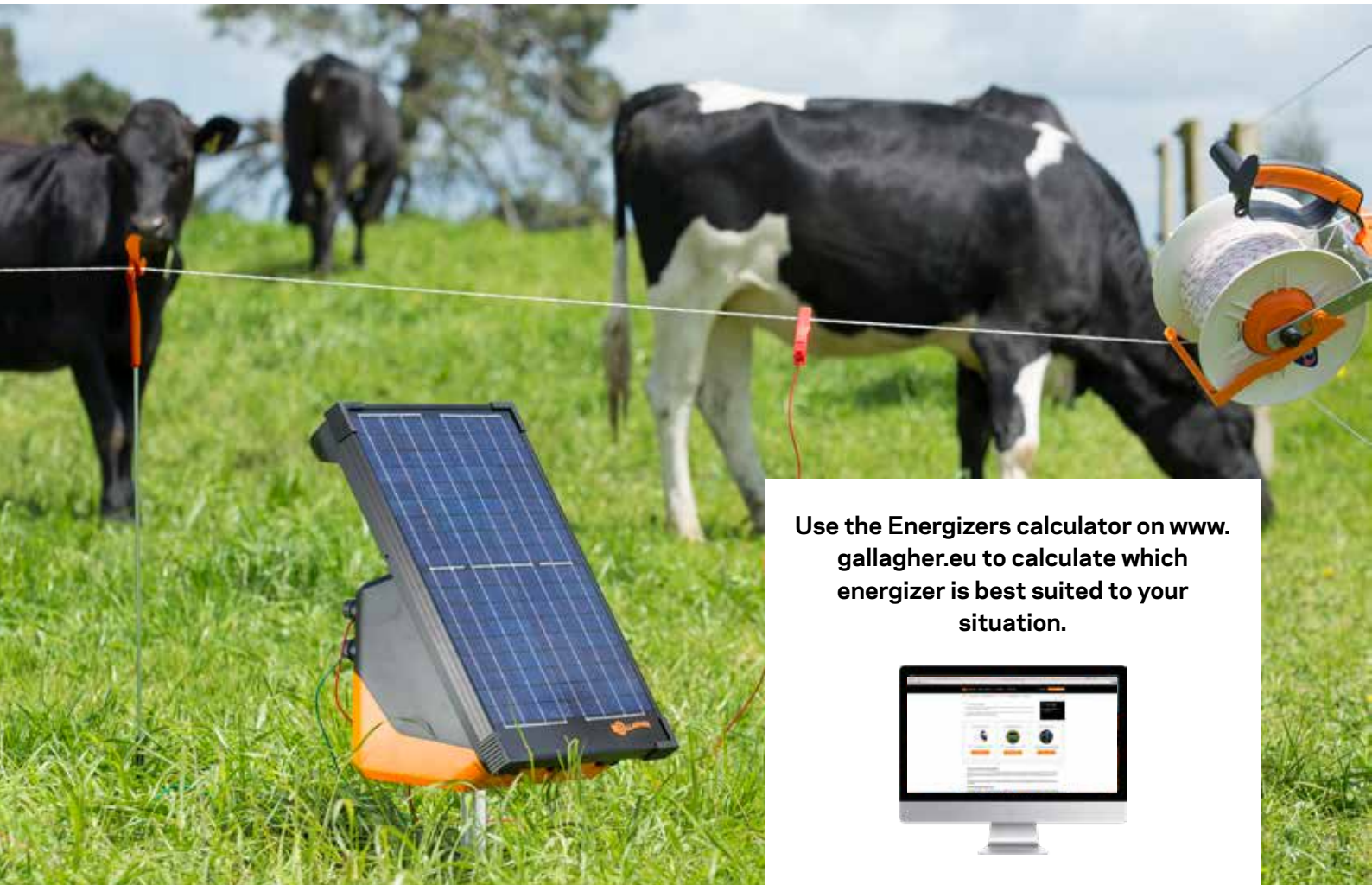

Use the Energizers calculator on www.gallagher.eu to calculate which energizer is best suited to your situation.



BATTERY

If you don't have 230V available nearby or if you move your fencing regularly, you can use our 9V or 12V energizers. They don't need mains. To extend the lifespan of a battery, we have energizers with a range of saver settings.



B300



Powerful battery energizer suitable for 12V use. Suitable for fencing up to 30km. Highly visible low battery and fence voltage indicator lights. Four easy to use Battery Save Options which can extend battery life by up to 12 months. Advised battery: Gallagher 12V 85 Ah (not included). Ideal in combination with solar energy.

B200



Powerful battery energizer suitable for 12V use. Suitable for fencing up to 20km. Highly visible low battery and fence voltage indicator lights. Four easy to use Battery Save Options which can extend battery life by up to 12 months. Advised battery: Gallagher 12V 85 Ah (not included). Ideal in combination with solar energy.



394008	B300	☞ = 1
068609	6W assist kit	☞ = 1

393001	B200	☞ = 1
068586	B200+6W solar assist	☞ = 1
068609	6W assist kit	☞ = 1

SPECIFICATIONS 12V ENERGIZERS

	max ⚡	500 Ω ⚡	100 Ω ⚡	(J) ⚡	max. ⚡	km 🌳	km 🌳	km 🌳	ha 🏠	🔋	12V ⚡	🔋	☀️	🔌	🔌	
B300 394008	10000	5800	1600	2,6	2	20	8	4	15	Optima YTR3,7L	200	71	30W	🔌	🔌	🔌
B200 393001	9000	4300	1400	1,45	1,1	13	5	3	10	Optima YTS2,7L	120	40	20W	🔌	🔌	🔌
B100 392004	10000	3500	1100	0,8	0,55	7	3	1	4	Optima YTS2,7L	60	35	10W	🔌	🔌	🔌
B60 350301	8000	5500	800	0,7	0,48	6	2	0,5	3	Optima YTS2,7L	45	-	10W	🔌		🔌



B100



Powerful battery energizer suitable for 9V and 12V battery use. Energizer for fencing up to 10km. Highly visible low battery and fence voltage indicator lights. Four easy to use Battery Save Options which can extend battery life by up to 12 months. Ideal in combination with solar energy.



392004	B100	☞ = 1
068609	6W assist kit	☞ = 1

B60



Entry level 12V battery powered energizer capable of powering up to 6km or 3 hectare of Multi-wire fence. Providing an effective electric shock on the fence from a small and easy to mount Energizer the B60 is designed for customers who require simplicity.



350301	B60	☞ = 1
--------	-----	-------

B50



Powerful device supplied by a 9 V disposable or 12 V storage battery. The LED shows red if battery voltage is low. 3 settings: full power, night mode and random. Battery savings options on 9 V battery (not 12V). Comes with connection for solar panel. Includes earth stake.



028931	B50	☞ = 1
--------	-----	-------

B40



The world's most energy efficient battery energizer! Only 9mA use in night safe mode. This means secure animal safety and ultra low battery consumption. Earth stake and battery included.



386317	B40	☞ = 1
068579	B40+4W solar assist	☞ = 1

B35



The B35 is a 9V Battery powered Energizer capable of powering up to 4 km or 1.5 hectare of Multi-wire fence. Providing a portable Energizer solution that is light and easy to move.



356433	B35	☞ = 1
7608	Earth Stake Stand for B20/B35	☞ = 1



B20



Feature-packed battery-operated device, powers fences up to 2km (without vegetation). Very easy to use. It operates on a 9V disposable battery or a 12V rechargeable battery. The device warns you when the battery is almost flat.



028818	B20	☞ = 1
7608	Earth Stake Stand for B20/B35	☞ = 1

B11



Robust Battery-unit on self-supporting stand with carry handle for simple installation. Features 4 Battery Save Options that can be selected using the external switch. Built-in indicator light flashes with each pulse. 12V battery leads and 6x1,5V batteryset included.



013534	B11 - incl. 6x1,5V	☞ = 1
---------------	--------------------	-------

B10



Robust Battery-unit, has a built-in indicator light that flashes with each pulse. Ideal for strip grazing & protecting gardens from small animals. Operates by 6 x 1,5V Alkaline batteries D-cell LR20 (not included), also suitable for 12 Volt lead/acid battery, 12V adapter kit available (004747).



003634	B10 - excl. 6x1,5V	☞ = 1
---------------	--------------------	-------

SPECIFICATIONS 9V ENERGIZERS



	max	500	100	(J)	max	km	km	10	Battery	9V	Battery	Circuit	Plug
B50 028931	8200	2900	1000	0,5	0,3	6	3	3/7	9V-160Ah	50	24	INTERNAL	EXTERNAL
B40 386317	7900	2100	500	0,4	0,27	6	3	2/5	9V-120Ah	40	9	INTERNAL	EXTERNAL
B35 356433	8300	1800	700	0,35	0,27	4	2	1,5/3,5	9V-55Ah	33	-	INTERNAL	EXTERNAL
B20 028818	9200	1800	800	0,20	0,15	2	1	1/2,5	9V-55Ah	25	-	INTERNAL	EXTERNAL
B11 013534	8200	1500	500	0,11	0,09	1	-	0,5/1,3	6X1,5V	20	-	INTERNAL	EXTERNAL
B10 003634	7900	1200	400	0,1	0,07	1	-	0,5/1,3	6X1,5V	15	-	INTERNAL	EXTERNAL

WHICH BATTERY FITS THE FOLLOWING PORTABLE ENERGIZERS

		B20	B35	B40	B50	B100	B200	B300	S10	S16	S20	S40	S100	S200	S400
		028818	356433	386317	028931	392004	393001	394008	341309	341216	341323	345307	346304	360300	361307
6Volt	075188 - 4Ah								▪	▪	▪				
	200590 - 7Ah														
	000459 - 10Ah											▪			
9Volt	007578 - 55Ah	▪	▪	▪	▪										
	008704 - 120Ah	▪	▪	▪	▪										
	008711 - 160Ah	▪	▪	▪	▪	▪ (2x)									
	048588 - 175Ah	▪	▪	▪	▪	▪ (2x)									
	063451 - 210Ah	▪	▪	▪	▪	▪ (2x)									
12Volt	047024 - 5Ah														
	000442 - 7,2Ah												▪	▪*	▪*
	047031 - 12Ah														
	033553 - 25Ah	▪	▪	▪	▪										
	033515 - 65Ah					▪	▪	▪							
	004171 - 85Ah					▪	▪	▪							
12Volt Optima	033409 - 105Ah														
	059621 - S2,7L					▪	▪	▪							
	059614 - R3,7L					▪	▪	▪							
	062096 - S5,5L														

* Parallel placement of two pieces is possible (= 12V + 2x 7.2Ah = 14.4Ah)



WHICH TYPE OF FENCING SUITS YOUR ANIMAL

The type of electric fencing that is best for you depends on your situation. Which animals do you keep? Are you looking for permanent or portable fencing? Would you like installation convenience or do you prefer minimal maintenance? All these questions determine your choice. Gallagher has a solution for every situation. We will be pleased to advise you!



FENCING SOLUTIONS

Permanent

Gallagher has permanent fencing available for every type of animal. For example, High Tensile is ideal for cattle or game and lasts up to 25 years. For horses, Gallagher recommends EquiFence. EquiFence is the most durable fencing for horses and is extremely safe because of the protective plastic cable.

Gallagher has the complete range of permanent fencing - from durable insultimber posts, topquality conductors to robust insulators.

Semi-permanent

At times you may wish to put up fencing for a longer period of time without it being permanent, when you lease pasture for example. In those situations Gallagher provides the solution with semi-permanent fencing.

Portable fencing

If you move the animals several times a year, we recommend portable fencing. Gallagher has a solution for every situation. For example, the SmartFence 2.0 is the ideal solution for sheep and goats.

Wolf fencing

Wolves are back after an absence of 150 years. Gallagher offers a number of special wolf-fencing concepts and will advise you without obligation. For more information go to page 78.



10-YEAR SYSTEM WARRANTY

If you use materials recommended by Gallagher: EcoPosts, Insultimber posts, Insulated Line Post, ElectroMax fencing wire, Equifence, reinforced S corner insulators, fixing wires, tension springs, rotating tensioners, Gallagher provides a 10-year system warranty.

Use the Fencing calculator to discover the type of fencing that is best suited to your situation.
www.gallagher.eu/compose-electric-fence





GALLAGHER SIGNATURE PRODUCTS

SMARTFENCE V2 - 10 POSTS, 4 WIRES AND REELS IN ONE SYSTEM

An ideal portable fence for sheep, goats and cows, it is so quick and easy to set up and is amazingly versatile.

You Tube SMART FENCE

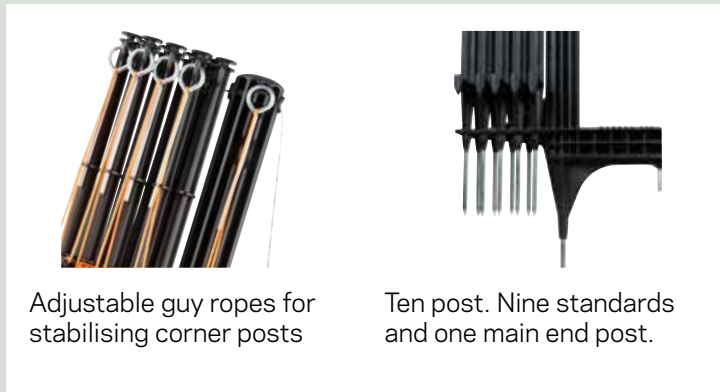

Adjustable guy ropes for stabilising corner posts

Ten post. Nine standards and one main end post.

GALLAGHER PATENTED SOLUTION



All in one, four wire, 100m, fully portable instant fence system.

Very quick and easy to assemble and easy to carry and store away.

Can be connected to any energizer for instant electric fence protection.

Maximum fence length 100 metres

RING TOP POST - EXTREMELY STRONG, ERGONOMIC AND DURABLE FENCE POST

With a head that won't wear through, a strong footplate that won't bend under pressure and a design that reduces tangling, this post combines more strength with less frustration.

You Tube RING TOP POST

GALLAGHER PATENTED SOLUTION



35% faster to separate from a bundle

100% Wear Proof, Tangle Proof, Stomp Proof

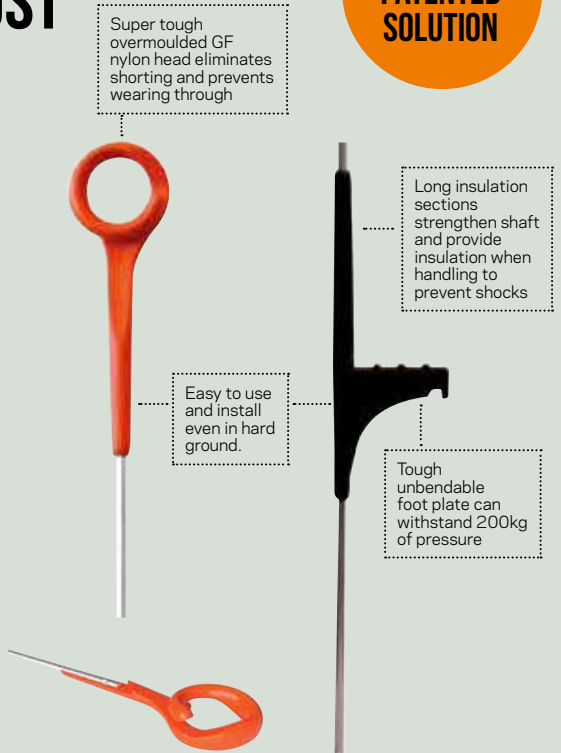

Super tough overmoulded GF nylon head eliminates shorting and prevents wearing through

Long insulation sections strengthen shaft and provide insulation when handling to prevent shocks

Easy to use and install even in hard ground.

Tough unbendable foot plate can withstand 200kg of pressure



GALLAGHER SIGNATURE PRODUCTS

XDI RING INSULATOR

A robust ring insulator for fitting plastic wire/cord to wooden posts. Cleverly designed to guarantee no shorts.

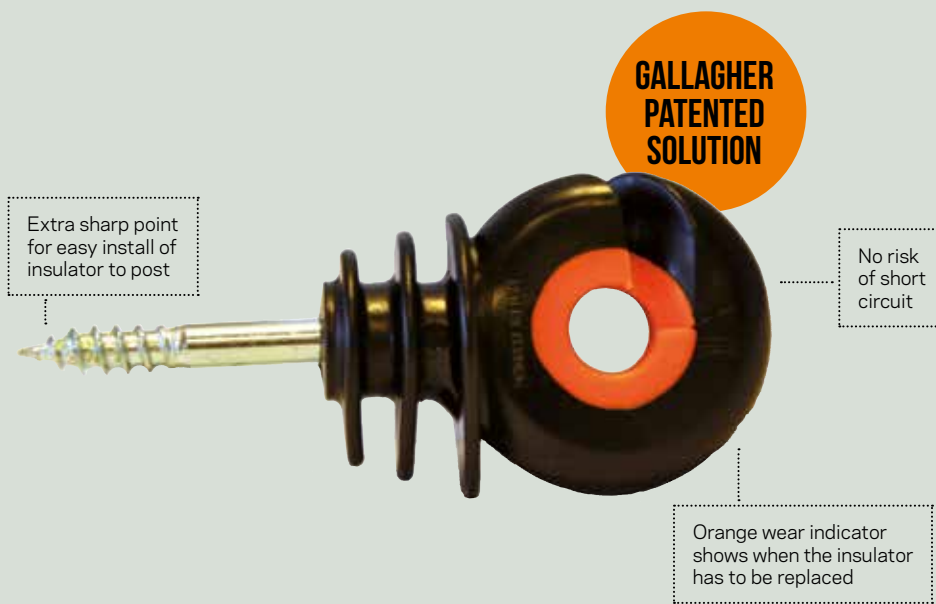

Screw-in aid
A handy, time saving tool that drills in ring and screw insulators.



MOVE AN ENTIRE FENCE WITHIN MINUTES USING TUMBLE WHEELS

The strip grazing system, saves time and is easy to use and leads to reduced grazing cycles and higher yields.

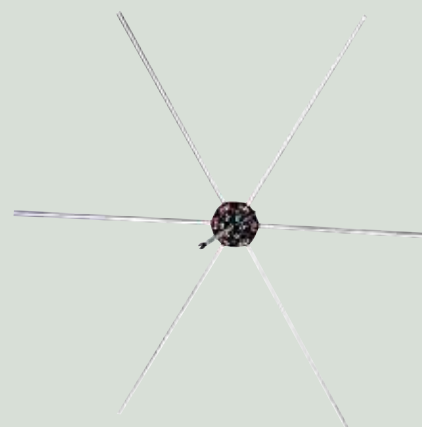



BATTERIES

To power a 9V or 12V energizer, you need a Gallagher battery. A Gallagher 12V energizer and an Optima 12V battery are the ultimate combination! The Optima battery is the most environmentally-friendly solution, because of its durability.

9V Powerpack Alkaline battery

9v

Environmentally friendly alkaline 9V battery for use with 9V battery powered energizers. Alkaline Batteries give you up to 30% better performance than Air Oxygen batteries. Suitable for all Gallagher 9V energizers.

007578	9V/55Ah - 160x110x115mm	☞ = 1
008704	9V/120Ah - 160x110x115mm	☞ = 1
008711	9V/160Ah - 190x125x160mm	☞ = 1
048588	9V/1.75Ah - 190x125x160mm	☞ = 1
063451	9V/210Ah - 190x125x160mm	☞ = 1



12V SLA Battery

12v

Maintenance free batteries. Suited for powering battery energizers. The 25Ah is a sealed lead/acid battery. Fits into the case of our 9Volt energizers when using a solar panel.



033553	12V/25Ah - 166x175x125mm	☞ = 1
--------	--------------------------	-------

Battery Charger CTEK

12v 5

Most batteries loose charge during winter time. Prevent this by connecting your battery to this maintenance charger. Your battery will remain charged! Essential for your battery during winter time. This charger is capable to charge all batteries up to 105Ah.



056707	12V XS 0,8 EU	☞ = 1
567299	6V XC 0,8 EU	☞ = 1

12V Battery

12v

A maintenance-free, 12V battery that provides reliable and consistent power.

This long life battery can be used as a power supply for 9V devices.



033409	12V/105Ah LA - 353x175x190mm	☞ = 1
004171	12V/85Ah LA - 278x175x190mm	☞ = 1
033515	12V/65Ah - 242x175x190mm	☞ = 1

6V Round Alkaline battery

6v

Environmentally friendly alkaline 6 Volt battery 90 Ah for use with battery powered energizers.



055661	6V/90Ah - 180x180x170mm	☞ = 1
--------	-------------------------	-------



THE BENEFITS OF OPTIMA 12V BATTERIES

The optima battery energizer is the most economical and most environmentally-friendly solution, because of its durability.

- Ideal for seasonal use.
- Guaranteed the best purchase.
- Very good charge acceptance.
- Smaller than traditional battery energizers, easy to carry.
- Ideal for winter storage because of its very low self-discharge.
- Cost savings, as it lasts more than twice as long.
- It combines ideally with solar panels, because of its minimal internal resistance.

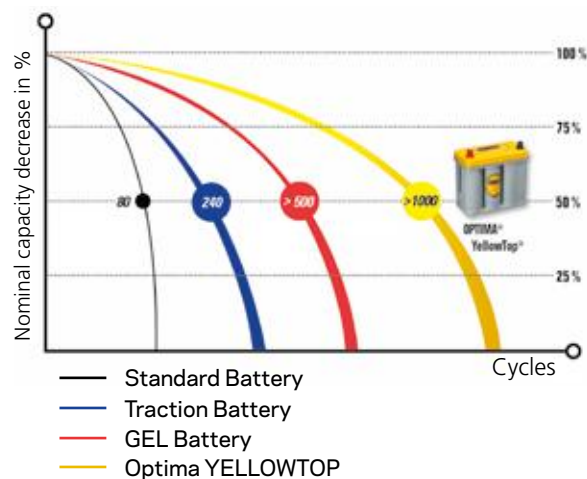

	059621 S2,7L	059614 R3,7L	062096 S5,5L
Length in mm	228	229	317
Total length in mm	237	237	325
Height without posts in mm	201	168	218
Height with posts in mm	227	197	238
Width in mm	121	172	158
Total width in mm	129	172	165
Nominal voltage (V)	12	12	12
Cold start power (EN)	460	660	975
Capacity in Ah (EN)	38	48	76
Reserve capacity (BCI) in Min	66	98	155
Weight in KG	11,8	16,6	26,5

CHARGE YOUR BATTERY REGULARLY DURING THE WINTER MONTHS!

12V Optima Yellowtop

12V

Uncompromising Quality! This Optima S2,7L 12V battery can be compared with a regular 65Ah 12V battery, but is smaller in size, lighter in weight and has a longer life. Ideal for use with solar modules. Extremely fast recharge with all common, regulated chargers.

Volume 2,7 litres, dimensions L237xH227xW129mm.



059621 12V/S2,7L - 237x227x129mm ☞ = 1

059614 12V/R3,7L - 237x197x171mm ☞ = 1

062096 12V/S5,5L - 325x238x165mm ☞ = 1



FENCING SETS

Gallagher offers a wide range of kits - for pets, herons, horses or chickens!! Every kit includes an energizer and they are all easy to install.

Horse kit B60



The starters kit for horses and ponies has everything you need to set up a small paddock for you horse or divide existing ones. Installing is made easy due to the step by step manual. The kit includes: B60 (12V), PowerLine tape 12.5mm (200m), Vario posts 1m (10 pcs.), Screw-in insulator (25 pcs.), Soft touch gate handle, Warning sign, Earth peg, Gate handle anchor (5 pcs.).



072323 12V Horse kit B60

☘ = 1

Poultry kit B60



A complete kit for setting up 50 metres of electric netting 44" (112cm) to keep your poultry in and protect them against predators. Installing is made easy due to a step by step manual. The kit includes: B60 (12V), Poultry netting; double spike, 112cm (50m), Earth peg, Warning sign.



072309 12V Poultry kit B60

☘ = 1

Garden & Pond kit M10



A complete fencing kit to keep pets or small animals in or out. Installing is made easy due to the step by step manual. The kit includes: M10 (230V), Hobby post 0.75m (Terra, 10 pcs.), Insulator (25 pcs.), Vidoflex 3 (Green, 100m), Earth peg, Cable set universal and Warning sign.



072347 230V Garden & Pond kit M10

☘ = 1

Garden & Pond kit B10



A complete fencing kit to keep pets or small animals in or out. Installing is made easy due to the step by step manual. The kit includes: B10 (6x 1,5V), Hobby post 0.75m (Terra, 10 pcs.), Vidoflex 3 (Green, 100m), Insulator (25 pcs.), Earth peg, Warning sign.



072330 9V/12V Garden & Pond kit B10

☘ = 1



Starter kit M10



Kit includes M10 (220V), earthing plate, warning sign, connecting cable and wire clip. To keep in pets (e.g. dog) or deter small predators and other animals (e.g. stone martens, the neighbour's cat, herons, etc.). For gardens smaller than 20 x 60m.



065189 230V Starter kit M10 ☹ = 1

Heron kit M10



A basic system for a fence around your pond. Through this safe, highly effective fence system your pond is a prohibited area for herons, prevents them from eating fish from your pond. The system includes an energizer with wall clip, 10 border posts, 20 clips, 100 meters of black plastic wire and connecting wire. The material is suitable for a 2-wire fence with a total length of 50 meters.



021727 230V Heron kit M10 ☹ = 1

021789 100m extension wire black ☹ = 1

SnailFence kit M10



Gallagher's "Out of the Box" solution: to keep out the neighbour's Cat, to keep Pine Martens out of the attic, and of course to keep killer snails away from your vegetable garden. Content: 1x Gallagher M10 Energizer, 1x 20 meter Snail Fence tape, 1x Junctionbox, 200x Screw M3x12, 10mtr Fence cable, 1x Mountingkit, 1x Manual.

075850 230V SnailFence kit M10 / 20m ☹ = 1

077427 Snailfence tape extension kit 20m ☹ = 1



077434 Snailfence tape extension kit 50m ☹ = 1

500041000 Fencing tape/Snailtape Junctionbox ☹ = 1

ELECTRIC FENCING ON A WOODEN FENCE – HOW DOES THAT WORK?

An animal is given shock when it connects the + and - wires. The bottom wire (-) operates as the earthing. When a cat touches the fence with its paws, it will make contact with the earth wire (-). It then closes the circuit by touching the + wire with its head. This produces a shock effect, which makes the cat jump back into the garden.

4.000V
IMPULSE TENSION



ELECTRIC FENCING FOR DOMESTIC ANIMALS IS HARMLESS!

An electric fence is based on the principle of a very short pulse being transferred over a wire. This pulse creates a current flow that is conducted over the skin instead of over the body. This ensures that only a shock reaction is created and no harm is done to the animal.





SECURITY MEASURES AND TESTERS

Would you like to prevent your animals from escaping as result of a lack of current? Would you like to know what caused the short-circuit in your fencing? Do you want to protect your energizer against a lightning strike? You can with our range of protectors and testers!

Cut out switch



By using a switch, you can divide your fence into several sections and switch them on and off independently of each other. This will also help you trace any faults that occur.



060705 Cut out switch

☞ = 1

Knife Cut-Off Switch



This switch helps you to switch off a part of the fencing for maintenance, for use for passages and gates or when you are looking for faults. The switch also offers the option to divide the fence into different plots. It can also be used to switch the fence on or off on the spot.

The switch is made of stainless steel, visible from a distance, and is supplied with fitting screws.



000770 Knife Cut-Off Switch

☞ = 1

Lightning diverter



The only adjustable lightning diverter on the market, suitable for every energizer. Protects the energizer against damage through lightning by diverting the lightning from the fence to ground (earth). The lightning diverter needs to be mounted between the fence and the energizer. Can withstand multiple lightning strikes.



064802 Lightning diverter

☞ = 1

Flood gate controller



Device especially for ditches that can be mounted on a fence. It stops the current flowing through the bottom line if the water (or another resistance) reaches the bottom wire. The rest of the wires will keep its voltage. Has a resistance of 5600 Ohm.



1506 Controller 5600 Ohm

☞ = 1

Security kit



The Security Kit protects your Maxi master from possible theft. The kit is very easy to install and can be used with all B100, B200, B300, S220 and S230 models.



057002 Security Kit

☞ = 1

FoxlightS



The way to protect your venerable animals against attacks from foxes and other night predators. 9 LED bulbs blink randomly so that the illusion is created for predators that someone is patrolling the area. 6 Volt battery is not included.



061716 FoxlightS

☞ = 1

002169 6V Battery for FoxlightS

☞ = 1



Vandal proof box



A galvanised box that protects battery and fence units. To deter vandals, the box is connected to the energizer and can be locked with a padlock (not included). Fits max.350x160x240mm sized Energizers and max.360x260x230mm sized Battery.
Dimensions incl.foot, 395x295x500mm. Suitable to place on Insultimber post 10x10cm, (not included, partnr. 017904). Ideal for B60/B80/B180/B280 and others.



019410 Electrified Vandal Proof Box ☞ = 1

Energizer and Battery Box



Portable box for electrical equipment and batteries. Maximum size of the battery 34 cm deep x 23 cm wide. Suitable for B60/B80/B180/B280. Other energizers will fit with little changes.



025237 For e.g. B Series ☞ = 1

Gallagher Solarbox

Portable box for energiser, battery and solar panel. Suitable for:
Max. size of energiser:
380x110x300mm (lxwxh).
Max. size of battery:
330x175x240mm (lxwxh).
Gallagher solar panel 10W, 20W and 30Watt.



073511 Gallagher Solarbox ☞ = 1

077328 50/60W Solar panel bracket ☞ = 1

Crocodile clip



Crocodile clip



400174 Clip black ☞ = 5

400204 Clip red ☞ = 5

400211 Clip green ☞ = 5

Lead set

9V		Multi Power						Solar		
B10	B20 B35	B40 B50	B60	B100 B200 B300	MB150 MB300	MBS200 MBS400 MBS800	MB1000 MB1800i MB2800i	S10 S16 S20 S40	S100 S200 S400	S220 S230

004938		Cable set to connect the energizer to the fencing and the earthing.	☞ = 1																		
201276		Cable set to connect the energizer to the fencing and the earthing.	☞ = 1																		
005499		Cable set to connect a 9 Volt energizer to a 12 Volt battery.	☞ = 1																		
001015		Replacement cable set to connect the B60 to a 12V battery.	☞ = 1																		
004747		Cable adapter to connect a B10 to a 12 Volt battery.	☞ = 1																		
201283		Cable set to connect an energizer to a battery.	☞ = 1																		
053865		230V/12V adapter to connect MultiPower energizers to 230V.	☞ = 1																		
401218		230V/15V Power supply suitable for Gallagher MB/MBS Energizers.	☞ = 1																		
401324		230V/15V power supply to connect an energizer with 230V.	☞ = 1																		

* In combination with cable set 201283

** In combination with cable set 005499



EU Warning sign

2

Warning signs must be attached to any electric fence every 50 metres wherever the fence borders a public right of way.



075881 Universal Warning sign

☞ = 1

Electric fence Keyring Beeper

NEW

A very handy and simple tester which can be attached to a key ring. Hold it close to an electric fence and it will give a loud beep if the fence is active.



079667

☞ 1

Live fence indicator

2

The Live fence indicator is fitted to the fence and flashes with each pulse of the energizer so you can see whether the fencing is still working correctly.



511009 Live fence indicator

☞ = 1

Neontester

A convenient tool for checking whether there is sufficient voltage at the electric fence. Not suitable for checking earth systems.

Range: Led 1, 1,0kV > 1,8kV, Led 2, 1,9kV > 2,5kV, Led 3, 2,6kV > 3,8kV, Led 4, 3,9kV > 4,8kV, Led 5, 4,9kV >



015019 Neontester

☞ = 1

Fault Finder

Pinpoints faults quickly and easily whatever type of wire or energizer is used. By simultaneously measuring the current flow and voltage, the Fault Finder will follow the current flow to any one of a series of faults.



509051 Fault Finder

☞ = 1

202068 Battery Fault Finder

☞ = 1

Fence Volt Meter

Supplies exact information on the condition of your fence. Makes targeted trouble shooting very easy. Auto ON/OFF. Helpful tool for checking earthing system. Powered by one 9V battery (a life of 6-12 months). Displays fence voltage from 100V up to 12kV.



015033 Fence Voltmeter

☞ = 1

GUARDING YOUR ANIMALS

The SMS Fence Alarm is a unique plug and play security system for your fence. In comparison with the existing systems, this product is a true breakthrough. It warns you with a text message if there is insufficient voltage (e.g. due to vegetation) or when the fencing is interrupted (e.g. when a gate is opened). You can divide your fence into 2 zones for accurate problem detection. It works for a whole season on 3 standard batteries (not included).

SMS fence alarm

2

The SMS fence alarm is a unique plug & play security for your fence. Compared with the existing devices this product is in another league. The SMS Fence alarm warns you via SMS if the voltage is too low.



055654 SMS fence alarm

☞ = 1



WHY SHOULD I INSTALL A SMS FENCE ALARM?

- Theft (*).
- Certainty that there is sufficient voltage at the end of the fencing.
- Works independently. Does not have to be connected to the energizer's battery (100% self-sufficiency).
- An immediate alert in the event of theft of the energizer.

(*) As it is vulnerable to theft, it is recommended to install the Fence Alarm separate from the energizer

CONDUCTING WIRES

The conducting wire in electric fencing is of crucial importance, because it transports the current. Even though all conducting wires would appear to be the same, there is a big difference in terms of price and quality. There are also differences in use. The Gallagher range consists of tape, cord, plastic wire, Equifence and High Tensile. Each of them with their different conductivity, durability and design. Make sure you choose the right conducting wire for your use!

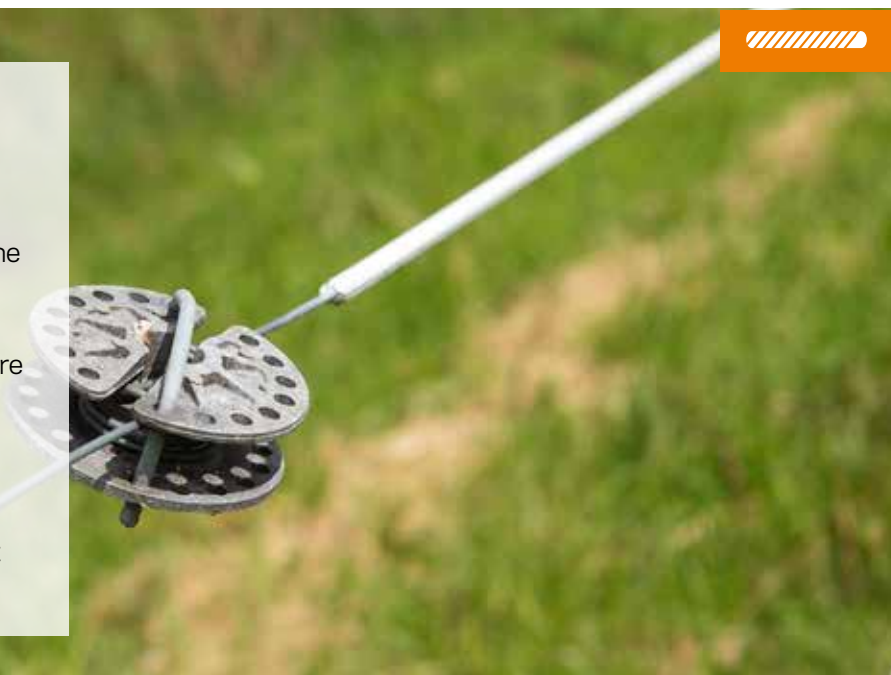

EQUIFENCE

This is the most durable and safe Gallagher fencing for horses. EquiFence consists of an elastic plastic cable with a galvanised core. The 3mm thick plastic casing protects the horse against the zinc-aluminium core. The plastic casing has been made conductive by means of three carbon lines. Fitting a Gallagher EquiFence fencing requires experience, so please contact your Gallagher specialist.



Core 2.5 mm aluminiumcoated wire.

Black carbon lines produce the conductive properties of EquiFence.

UV-resistant.

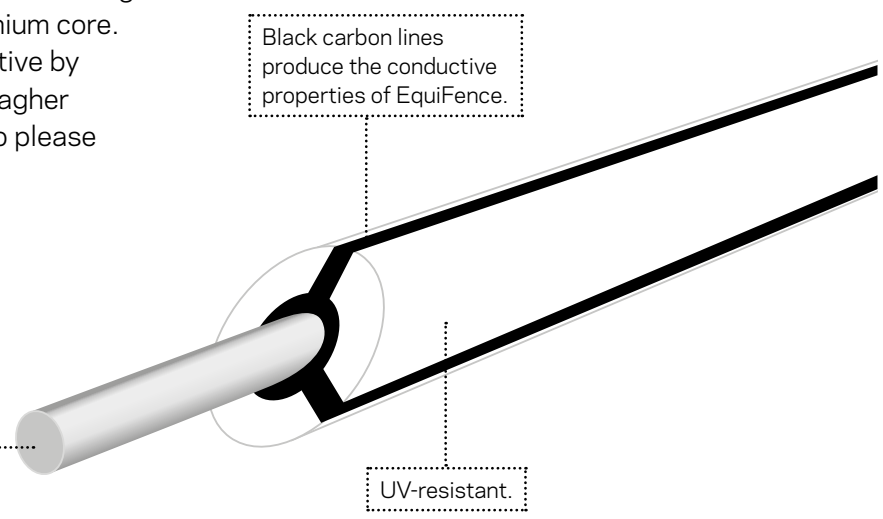

Equifence



The safest solution for your horse. Unique electrically conductive polymer (in black stripes) allows use as electric fence wire. Provides you, in combination with tension springs, ultimate safety for your horse. Total diameter of 7.5mm with a core of 2.5mm high tensile wire.



009124	White - 7,5mm - 250m - 20kg	☞ = 1
053858	Terra - 7,5mm - 250m - 20kg	☞ = 1



HIGH TENSILE

This aluminium-coated wire is many times better than any other steel wire. An aluminium coating on the 2.5mm thick core ensures superior conductivity of up to 15x more than a normal 2.5mm steel wire. The tensile strength of the wire is also particularly high at up to 500 kg. You can tension the wire very tightly and when used in combination with tension springs, you can work with a distance of 20m between posts. This produces considerable cost savings per metre.

ELECTROMAX 2.65MM

Particularly suitable for fencing that requires increased conductivity and control.

- 15% better conductivity than standard 2.5mm aluminium-coated wire
- Patented, advanced zinc-alu alloy coating produces superior corrosion resistance.

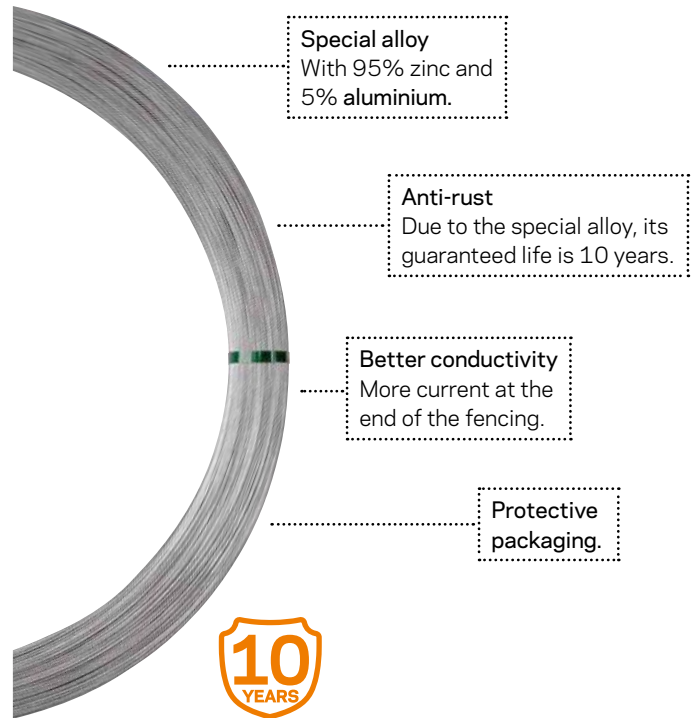

ElectroMax wire



15% more conductive than standard 2,5mm high tensile wire. Carries power further and handles shorts better. Patented zinc-alu alloy outer surface for up to 3 times longer life than standard high tensile wire.



069385 HT - ø2,65mm - 600m - 26kg 🌀 = 1

Zinc-alu-mag wire



Steel cored, high tensile fence wire with an aluminium coating for longer life and greater conductivity. Permanent Wire Tensioner and Tension Springs can be used to strain the wire.



039999 HT - ø2,5mm - 625m - 25kg 🌀 = 1

077311 HT - ø1,8mm - 1250m - 25kg 🌀 = 1

004188 HT - ø1,6mm - 1580m - 25kg 🌀 = 1

004195 HT - ø1,6mm - 315m - 5kg 🌀 = 1



Zinc-alu-mag wire



Erecting a permanent fence becomes very simple with this aluminised fencing wire. Easier to bend than regular HT wire, but strong enough to keep sheep, cattle or game in/out. Very low resistance, which makes this wire ideal for long fence lines.



Stranded wire

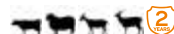

High conductive 7 strand galvanized wire for long portable fences which are affected by growth. To be used with rabbit, fox, pig, and sheep fences.



060412 MT - ø1,8mm - 500m - 10kg ⚡ = 1

008759 ø2mm - 200m - 3kg ⚡ = 1

007806 ø2mm - 400m - 6kg ⚡ = 1

SPECIFICATIONS WIRE CONDUCTORS



H.T. zinc-alu wire 1,6mm	004195 004188		315m 1580m	8kV	7,5kV	7kV	0,07	220	▪		500 >	zinc aluminium coating
M.T. zinc-alu wire 1,8mm	060412		500m	8kV	7,6kV	7,1kV	0,067	250		▪	500 >	zinc aluminium coating
H.T. zinc-alu wire 1,8mm	077311		1250m	8kV	7,7kV	7,3kV	0,05	350	▪		500 >	zinc aluminium coating
H.T. zinc-alu wire 2,5mm	039999		625m	8kV	7,8kV	7,5kV	0.035	500	▪		500 >	zinc aluminium coating
High conductive fence wire 2,65mm	069385		600m	8kV	7,9kV	7,8kV	0,029	550	▪		500 >	zinc aluminium coating
EquiFence 7,5mm	009124 053858	White Terra	250m 250m	8kV	7,7kV	7,5kV	0,035	500	▪		< 500	2.5mm galvanised wire with non-conductive plastic casing and 3 conductive carbon cores.





CORD, SOFT VERSION

portable and permanent fencing

Cord is a conductive plastic wire suitable for fencing for cattle and horses. Available in a EconomyLine, PowerLine or TurboLine version.

EconomyLine and PowerLine

For fencing that is shorter than 500 metres. PowerLine conductors are made of durable top-quality plastic and stainless steel.

TurboLine

For fencing that is longer than 500 metres. With a Turboline conductor you are certain you have the absolute top in conductors.

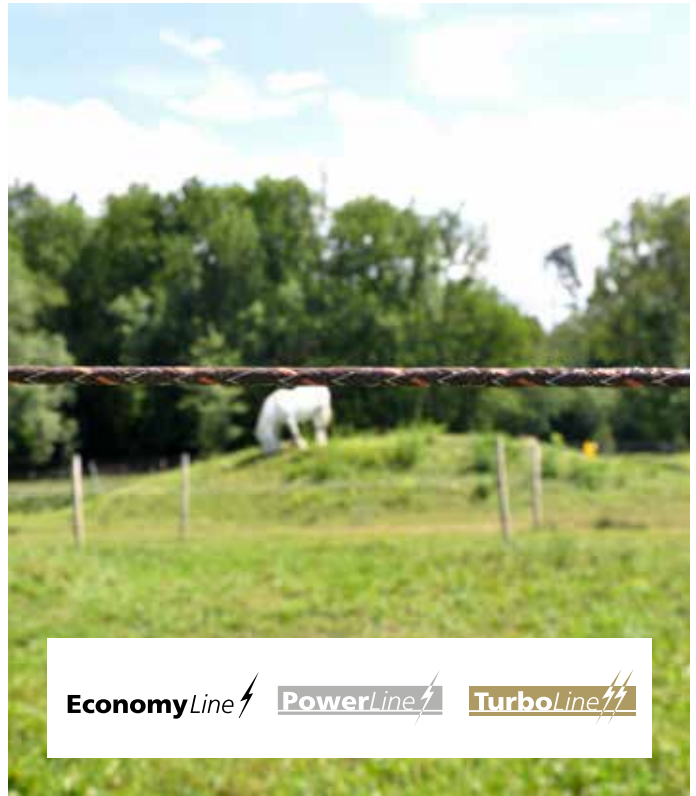

⚡ EconomyLine rope



PowerLine Rope for semi permanent fences, suitable for horses and cattle. With 5 stainless steel wires for high conductivity. UV stabilised. Post spacing up to 8m.

⚡ PowerLine rope



Braided PowerLine Rope for (semi) permanent fences, suitable for horses and cattle. With 5 stainless steel wires and 1 tinned copper wire for high conductivity. UV stabilised. Post spacing up to 8m.



063918	White - 100m	☞ = 1
063925	White - 200m	☞ = 1
063932	White - 500m	☞ = 1
063949	Terra - 200m	☞ = 1



063956	White - 200m	☞ = 1
063963	Terra - 200m	☞ = 1
072453	White - 500m	☞ = 1
072460	Terra - 500m	☞ = 1





⚡ TurboLine rope



Braided TurboLine Cord prevents a lot of stretching and ensures a long life. By using 3 tinned copper wires in combination with 8 stainless steel wires an optimal conductivity is realised. Soft-touch cord provides high safety for your animals.



057856	White - 200m	☞ = 1
056101	Terra - 200m	☞ = 1
058006	White - 500m	☞ = 1
057993	Terra - 500m	☞ = 1

SPECIFICATIONS CORD



Economy Line Cord 5mm	063918	White	100m	8kV	2kV	1kV	3,82	330	5		< 500
	063925	White	200m								
	063932	White	500m								
	063949	Terra	200m								
PowerLine Cord 5+mm	063956	White	200m	8kV	4,5kV	2,5kV	0,18	330	5	1	< 500
	072453	White	500m								
	063963	Terra	200m								
	072460	Terra	500m								
TurboLine Cord 6+mm	057856	White	200m	8kV	7,5kV	7kV	0,06	430	8	3	500 >
	058006	White	500m								
	069293	White	2x200m								
	069798	White	2x500m								
	056101	Terra	200m								
	057993	Terra	500m								
	069309	Terra	2x200m								
069804	Terra	2x500m									





PLASTIC WIRE VIDOFLEX

portable fencing

Vidoflex is ultralight and extremely durable. The 3, 6, 9 and 12 next to the name Vidoflex note the number of current wires that have been incorporated for conductivity. The conductive wires of Vidoflex 9 and 12 TurboLine are made of a special alloy that is particularly conductive.

EconomyLine and PowerLine

For fencing that is shorter than 500 metres. PowerLine conductors are made of durable top-quality plastic and stainless steel.

TurboLine

For fencing that is longer than 500 metres. With a Turboline conductor you are certain you have the absolute top in conductors.



⚡ Vidoflex 3 PowerLine



Polywire with 6 Stainless Steel wires. Suitable for short portable fences. Available in 100m (brown) and 200m (white).



063987	Terra - 100m	⚡ = 1
019335	Green - 100m	⚡ = 1
010554	White - 200m	⚡ = 1

⚡ Vidoflex 6 PowerLine



Thick polywire with 6 stainless steel wires providing excellent conductivity. Ideal for portable fences. UV stabilised and high tensile strength for longer life.



021680	White - 200m	⚡ = 1
063970	Terra - 200m	⚡ = 1
021697	White - 400m	⚡ = 1
054855	Terra - 400m	⚡ = 1
072422	White - 1000m	⚡ = 1

⚡ Vidoflex 9 TurboLine Plus



52% stronger than traditional polywire. Will not twist or kink when winding onto reels. Ideal for long portable fences, the patented mixed metal conductive wires carry the pulse 40 times better than standard PowerLine wire. Always use TurboLine products if fence > 500m.

011247	White - 200m	⚡ = 1
011254	White - 400m	⚡ = 1
054862	Terra - 400m	⚡ = 1
049028	White - 1000m	⚡ = 1
075775	Terra - 1000m	⚡ = 1





⚡ Vidoflex 12 TurboLine



The most conductive TurboStar poly wire -3.0mm- for portable fencing. The 6 stainless-steel wires and 4 galvanised copper wires conduct 80 times better than a standard poly wire. This TurboLine Plus model is 50% stronger, does not stretch and is even more clearly visible. Available in white. It has a 5-year UV warranty.



079377	White - 400m	☞ = 1
--------	--------------	-------

⚡ TurboLine Blue Polywire



Blue polywire specially developed to keep wild animals out, in specific wild boars. Studies show that wild boars have poor eyesight and primarily see the color blue. Keep your crops safe by using this highly conductible wire.



400m now also available as a duo pack: save 30%!

075829	Blue - 400m	☞ = 1
072477	Blue - 1000m	☞ = 1
079384	Blue - 200m	☞ = 1

SPECIFICATIONS VIDOFLEX



PowerLine Vidoflex 3 2mm	010554 063987 019335	White Terra Green	200m 100m 100m	8kV	1,1kV	0,6kV	6,8	47	6	-	< 500	
PowerLine Vidoflex 6 2,5mm	021680 021697 072422 063970 054855	White White White Terra Terra	200m 400m 1000m 200m 400m	8kV	2,3kV	1,4kV	3,8	80	6	-	< 500	
TurboLine Vidoflex 9 3mm	011247 011254 049028 054862 075775	White White White Terra Terra	200m 400m 1000m 400m 1000m	8kV	7kV	6,4kV	0,06	105	6	3	500 >	
TurboLine Blue Polywire 3mm	075829 072477 079384	Blue Blue Blue	200m 400m 1000m	8kV	7kV	6,4kV	0,06	105	-	3	500 >	
TurboLine Vidoflex 12	079377	White	400m	8kV	7,4kV	6,9kV	0,046	105	6	4	500 >	





TAPE

portable and permanent fencing

Tape has reinforced edges. You recognise PowerLine tape by the black side wire. These properties guarantee a longer lifespan for the product. The TurboLine version can be recognised by the red side wire and has a 40x better conductivity because of the light-metal wires that have been incorporated in the conductor.

EconomyLine and PowerLine

For fencing that is shorter than 500 metres. PowerLine conductors are made of durable top-quality plastic and stainless steel.

TurboLine

For fencing that is longer than 500 metres. With a Turboline conductor you are certain you have the absolute top in conductors.



TurboStar

Extremely strong, super conductive tape for long, permanent equine fencing. Perfectly visible. The sturdy, conductive side wire in the edges provides extra strength. Power guaranteed from beginning to end due to excellent conductivity. The unique composition ensures 40x better conductivity than standard 40mm tape.

⚡ PowerLine tape



Highly visible tape with black reinforced edges. 11 thick stainless steel wires and 1 mixed metal wire for excellent conductivity.



006246	40mm - White - 200m	⚡ = 1
060696	40mm - Terra - 200m	⚡ = 1

⚡ PowerLine tape



Clearly visible PowerLine Tape with black reinforced edges. Ideal for semi-portable horse fencing. 5 thick stainless steel wires and 1 mixed metal wire for good conductivity. Post spacing up to 5m.



106236	20mm - White - 200m	⚡ = 1
062303	12,5mm - White - 100m	⚡ = 1
026237	12,5mm - White - 200m	⚡ = 1

⚡ TurboLine tape



Strongly conductive tape for portable cattle and horse fencing. Power guaranteed from beginning to end due to vertical stainless-steel wires. The blue colour makes this tape particularly suitable for keeping game animals away from your own animals, because wild animals see the colour blue particularly well.



079391	12,5mm - Blue - 200m	⚡ = 1
---------------	----------------------	-------

⚡ TurboLine tape



Very strong TurboLine Tape with reinforced red edges, suitable for semi-permanent horse fencing. Blends in with the surroundings so it is not so conspicuous. 40 times more conductive than standard Powerline tape. Post spacing up to 6m. Always use TurboLine products if fence > 500m.



007608	20mm - White - 200m	⚡ = 1
060702	20mm - Terra - 200m	⚡ = 1

⚡ TurboLine tape



Very strong TurboLine Tape with reinforced red edges, intended for permanent fencing for horses. 40 times better conductivity than standard 40mm PowerLine Tape. With 11 stainless steel wires 0,16mm and 4 mixed metal wires 0,25mm. Post spacing up to 6m.



007592 40mm - White - 200m ⚡ = 1

⚡ TurboLine tape



12,5mm TurboLine Tape. The horizontal wires are interconnected at 13 cm intervals ensuring better conductivity. 40 times more conductive than standard polytape. Ideal for portable electric fences. Post spacing up to 5m. 200m and 400m rolls. Always use TurboLine tape if fence > 500m.



076232 12,5mm - White - 200m ⚡ = 1
086231 12,5mm - White - 400m ⚡ = 1

⚡ TurboStar tape



TurboStar Tape is a premium 40mm tape which has the lowest resistance available today. It has 40 times better conduction than regular tape and will result in more power on your fence due to 10 stainless steel wires and 4 mixed metal wires. Post spacing up to 6m. The sturdy and breathable features prevent tensioning regularly. Available in white and terra on 100m rolls.



072439 40mm - White - 100m ⚡ = 1
072446 40mm - Terra - 100m ⚡ = 1
010608 40mm - White - 200m ⚡ = 1
010615 40mm - Terra - 200m ⚡ = 1
010516 40mm - Green - 200m ⚡ = 1

⚡ TurboStar tape



TurboStar Tape is a premium 40mm tape which has the lowest resistance available today. It has 40 times better conduction than regular tape and will result in more power on your fence due to 10 stainless steel wires and 4 mixed metal wires. Post spacing up to 6m. The sturdy and breathable features prevent tensioning regularly. Available in green, terra and white on 200m rolls and white and terra on 350m rolls.



070862 40mm - White - 350m ⚡ = 1
070879 40mm - Terra - 350m ⚡ = 1

SPECIFICATIONS TAPE



PowerLine Tape 12,5mm	062303 026237	White White	100m 200m	8kV	4,5kV	2,5kV	0,18	65	4	1				< 500
PowerLine Tape 20mm	106236	White	200m	8kV	4,5kV	2,5kV	0,18	175	5	1	▪			< 500
PowerLine Tape 40mm	006246 060696	White Terra	200m 200m	8kV	4,4kV	2,3kV	0,17	450	11	1	▪			< 500
TurboLine Tape 12,5mm	076232 086231	White White	200m 400m	8kV	6,4kV	5,3kV	0,09	100	3	2	▪	▪		500 >
TurboLine Tape 20mm	007608 060702	White Terra	200m 200m	8kV	6,4kV	5,3kV	0,09	200	3	2	▪	▪		500 >
TurboLine Tape 40mm standard	007592	White	200m	8kV	7,5kV	7kV	0,05	380	11	4	▪	▪		500 >
TurboStar Tape 40mm super	072439 010608 070862 072446 010615 070879 010516	White White White Terra Terra Terra Green	100m 200m 350m 100m 200m 350m 200m	8kV	7,5kV	7kV	0,04	520	10	4	▪			500 >



NETTING

Gallagher has wide range of netting for ideal and reliable portable/moveable fencing. Whether you need netting for sheep, chickens, rabbits, cats, dogs or goats, we've got it.

We would also like to introduce you to our ideal fencing for sheep and cattle. The SmartFence 2.0 is our pride and joy - the perfect alternative to standard fencing netting.

NETTING KEY

We have a wide range of netting. Please use the key to find the right netting for you. It enables you to find the specifications of the netting.

For example:

Orange 90/1 W 14/G - 50m

① ② ③④ ⑤ ⑥ ⑦

1. the colour of the netting
2. the height of the netting (cm)
3. 1= single pin
2 = double pin
4. with a reinforced bottom wire
5. the number of posts
6. the colour of the posts: G=green / W=white / B=black
7. length of netting

EuroNetz Wolf netting

Complete and user-friendly fencing netting to keep out wolves. The netting is 50m long and is 1.20m high. It has 14 posts with a double pin and a reinforced bottom wire to prevent it from being breached by gnawing or chewing. The netting is easy to erect and several nets can be linked together.



078677 Orange 120/2W14/G-50m ☞ = 1

EuroNetz Wolf netting

Fencing netting to protect your animals against wolves, with a plus/min connection. This means that the wires are connected alternately to the plus and minus pole of the energizer. If 2 wires are touched at the same time, the animal experiences a strong, brief shock. This system guarantees full voltage, even on surfaces where earthing is tricky. The netting has 14 posts with a double pin, it is 1.20m high, 50m long and extremely easy to use.



078684 Orange 120/2W14/G-50m ☞ = 1



EuroNetz Wild boar netting



Turbo netting against wild boars. Strong posts 19mm, best solution to prevent wild boars destroying your crops. An electric fence in combination with a budget physical barrier.



062973 White 75/1-14/W-50m ☼=1

EuroNetz Poultry netting



Do you have chickens that need to be moved regularly? This chicken netting is the ideal solution. It is user-friendly, complete, and has a total length of 50m. The netting includes 15 posts with single pin that have been incorporated into the netting. Several nets are easy to connect together.

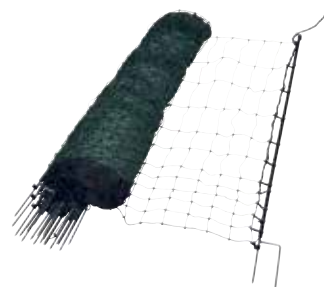

- 076833 Green 112/2-15/B-50m ☼=1
- 077298 Green 112/1-9/B-25m ☼=1
- 075867 Green 112/1-15/B-50m ☼=1
- 022229 Orange 112/1-15/G-50m ☼=1
- 022403 Orange 112/2-15/G-50m ☼=1

EuroNetz Rabbit netting/Hobby netting



Fencing netting for rabbits and other small pets. Can also be used for an allotment or a field. Complete and easy to attach to several other nets. Length 25m, 9 posts.

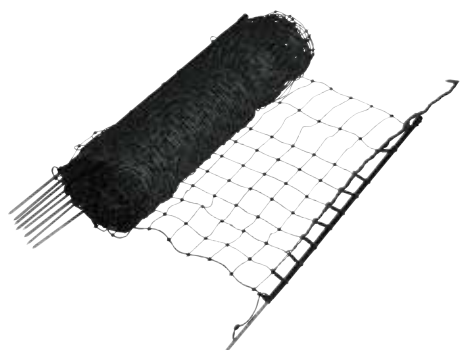

- 077281 Green 65/1-9/B-25m ☼=1
- 024377 Green 65/1-15/B-50m ☼=1
- 022182 Orange 65/1-15/G-50m ☼=1

EuroNetz Goat netting



Complete and easy to use portable netting for goats and lambs. If the pasture is bordered with ditches, netting offers even the newborn lambs maximum safety. Length: 50m. It is easy to connect nets together.



- 022168 Orange 105/1-14/G-50m ☼=1
- 022212 Orange 105/2-14/G-50m ☼=1

EuroNetz Gate for electric netting



A gate set for convenient opening or closing of net fencing. Easy to use and to connect to your net fencing.

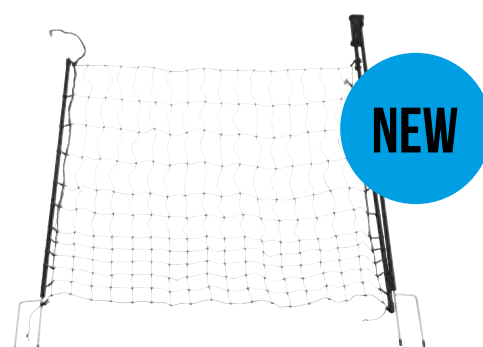

079360 Entry gate ☼=1



EuroNetz Sheep netting



Complete and user-friendly portable fencing netting for sheep and lambs. Also suitable as fencing near ditches so new-born lambs can stay in the pasture in complete safety. Length: 50m. Includes 14 posts with a single pin that are incorporated into the netting. Several nets are easy to connect together.



075379	Orange 90/1-14/W-50m	🔗 = 1
022175	Orange 90/2-14/G-50m	🔗 = 1
022106	Orange 90/1-14/G-50m	🔗 = 1
075768	Orange 90/2W14/G-50m	🔗 = 1
075386	Orange 90/2-14/W-50m	🔗 = 1

EuroNetz Combo netting



Combo netting: the netting with extra stability for use on rocky territory. Every 30cm the vertical wires are reinforced, resulting in a tighter net in rough terrain.

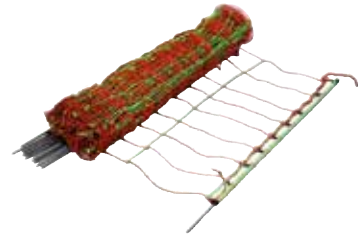

010356	Orange 90/1-14/G-50m	🔗 = 1
075584	Orange 90/2-14/G-50m	🔗 = 1
075546	Orange 90/2W14/G-50m	🔗 = 1
072415	Orange 105/1W14/G-50m	🔗 = 1
075539	Orange 105/2W14/G-50m	🔗 = 1

SPECIFICATIONS NETTING

	Type of use	Product description	Color netting	Color Post	Pin	Height (cm)	Lenght (m)	Nmbr of posts	Horizontal wires
022106		Sheep netting, Orange 90/1 - 14/G - 50m	Orange	Green	Single	90	50	14	8
022175		Sheep netting, Orange 90/2 - 14/G - 50m	Orange	Green	Double	90	50	14	8
075768		Sheep netting, Orange 90/2 W 14/G - 50m	Orange	Green	Double	90	50	14	8
075379		Sheep netting, Orange 90/1 - 14/W - 50m	Orange	White	Single	90	50	14	8
075386		Sheep netting, Orange 90/2 - 14/W - 50m	Orange	White	Double	90	50	14	8
022168		Goat netting, Orange 105/1 - 14/G - 50m	Orange	Green	Single	105	50	14	9
022212		Goat netting, Orange 105/2 - 14/G - 50m	Orange	Green	Double	105	50	14	9
077281		Rabbit-/hobby Netting, Green 65/1 - 9/B - 25m	Green	Black	Single	65	25	9	10
022182		Rabbit-/hobby Netting, Orange 65/1 - 15/G - 50m	Orange	Green	Single	65	50	15	10
024377		Rabbit-/hobby Netting, Green 65/1 - 15/B - 50m	Green	Black	Single	65	50	15	10
077298		Poultry netting, Green 112/1 - 9/B - 25m	Green	Black	Single	112	25	9	12
022229		Poultry netting, Orange 112/1 - 15/G - 50m	Orange	Green	Single	112	50	15	12
022403		Poultry netting, Orange 112/2 - 15/G - 50m	Orange	Green	Double	112	50	15	12
075867		Poultry netting, Green 112/1 - 15/B - 50m	Green	Black	Single	112	50	15	12
076833		Poultry netting, Green 112/2 - 15/B - 50m	Green	Black	Double	112	50	15	12
078677		Wolf netting, Orange 120/2 W 14/G - 50m	Orange	Green	Double	120	50	14	10
078684		Wolf netting, Orange 120/2 W 14/G - pos/neg - 50m	Orange	Green	Double	120	50	14	10
062973		Wild boar netting, White 75/1 - 14/W - 50m	White	White	Single	75	50	14	6
010493		Turbo netting, White 90/1 - 14/W - 50m	White	White	Single	90	50	14	8
025473		Turbo netting, White 90/2 - 14/W - 50m	White	White	Double	90	50	14	8
010356		Combo netting, Orange 90/1 - 14/G - 50m	Orange	Green	Single	90	50	14	9
075584		Combo netting, Orange 90/2 - 14/G - 50m	Orange	Green	Double	90	50	14	9
075546		Combo netting, Orange 90/2 W 14/G - 50m	Orange	Green	Double	90	50	14	9
072415		Combo netting, Orange 105/1 W 14/G - 50m	Orange	Green	Single	105	50	14	10
075539		Combo netting, Orange 105/2 W 14/G - 50m	Orange	Green	Double	105	50	14	10



EuroNetz Turbo netting



Strong, high quality turbo netting. With a stranded cord, which reinforces the top wire by 80%, for greater conductivity. Because of the low resistance it is ideal to connect more turbo nets together.

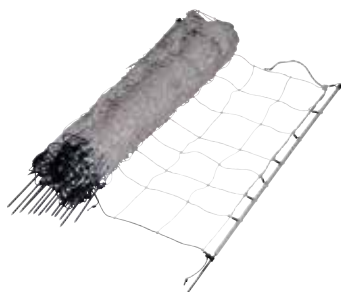

010493	White 90/1-14/W-50m	☞ = 1
025473	White 90/2-14/W-50m	☞ = 1

EuroNetz repair set

Repair Set Euro Netting



22104	Repair set Euro/Combo netting	☞ = 1
074747	Repair set Turbo netting	☞ = 1

	Type of use	Conducting wires	Weight (Kg)	Resistans Ohm/50m	Including repairset.	Characteristic	Repairset (part.no.)	Post (part.no.)
022106		7	5,9	46	Yes		22104	22101
022175		7	6,65	46	Yes		22104	22105
075768		7	6,19	46	Yes	Reinforced not conducting bottomwire	22104	22105
075379		7	5,9	46	Yes		22104	22112
075386		7	6,65	46	Yes		22104	22113
022168		8	6,78	41	Yes		22104	22106
022212		8	7,5	41	Yes		22104	22107
077281		9	4,86	41	Yes		22104	22111
022182		9	7,76	41	Yes		22104	22110
024377		9	7,76	41	Yes		22104	22111
077298		11	5,98	33	Yes		22104	22108
022229		11	10,8	33	Yes		22104	22108
022403		11	11,3	33	Yes		22104	22109
075867		11	9,45	33	Yes		22104	22108
076833		11	11,3	33	Yes		22104	22108
078677		9	7,6	41	Yes	Reinforced conducting topwire Reinforced not conducting bottomwire With additional ground clamp	22104	-
078684		9	7,6	41	Yes	Reinforced conducting topwire Reinforced not conducting bottomwire With plus/min connection	22104	-
062973		6	7,6	5	Yes		074747	-
010493		7	6,3	0,6	Yes		074747	22112
025473		7	7,05	0,6	Yes		074747	22113
010356		8	6,6	41	Yes	Vertical polyethylen struts	22104	22101
075584		8	6,95	41	Yes	Vertical polyethylen struts	22104	22105
075546		8	7,2	41	Yes	Reinforced not conducting bottomwire Vertical polyethylen struts	22104	22105
072415		9	8	42	Yes	Reinforced not conducting bottomwire Vertical polyethylen struts	22104	22106
075539		9	8,75	42	Yes	Reinforced not conducting bottomwire Vertical polyethylen struts	22104	22107



FENCING NETS - MESH WIDTHS

Sheep netting (orange)
Turbo netting (white)

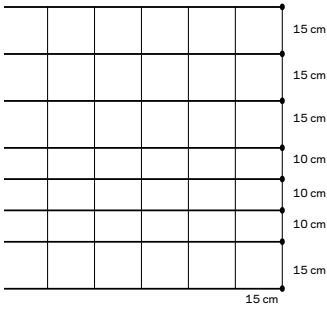

Poultry netting

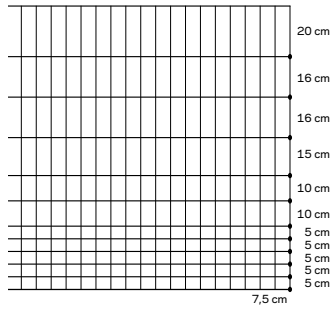

Goat netting

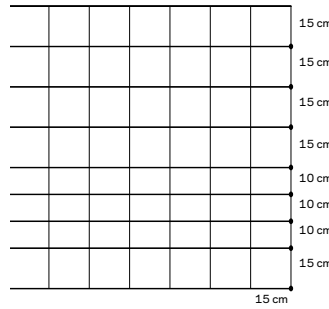

Rabbit netting (orange)
Hobby netting (green)

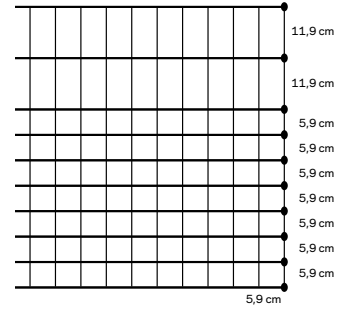

Combo netting - 90cm

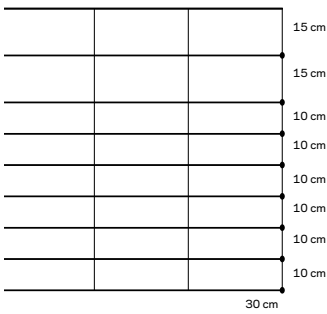

Combo netting - 105cm

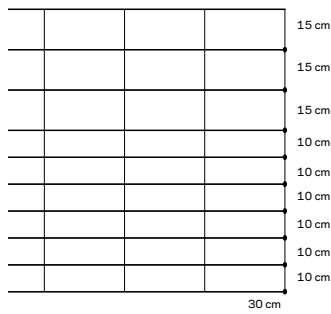

Wild boar netting

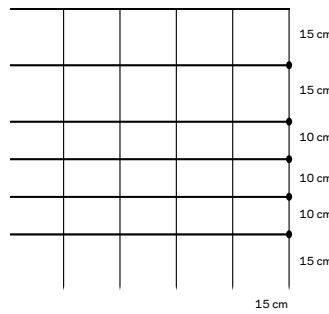

Wolf netting

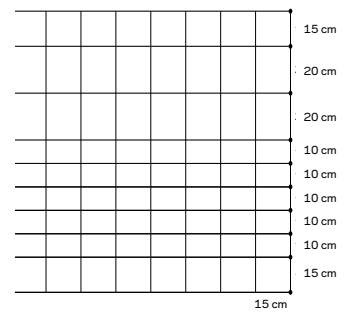

SmartFence 2.0



SmartFence 2.0 is the alternative product for netting. A revolution design where posts, reels and wires are combined into 1 product. Quick and easy to put up.



700007	SmartFence 2.0	☞ = 1
069750	PowerLine wire 3mm 100m	☞ = 1
700045	SmartFence 2.0 4Pack	☞ = 4
069767	TurboLine wire 3mm 100m	☞ = 1
065264	Battery drill adapter	☞ = 1



INSULATORS

With our range of insulators we provide a solution for every type of fencing.

Whether you use tape, cord, plastic wire, EquiFence or aluminium-coated wire, Gallagher has it all.

Our insulators stand out in terms of price, quality and durability.



XDI screw-in insulator wood



Improved screw-in insulator with unique advantages over traditional black screwing insulators. Much stronger due to the new technology.



025510	For (poly) wire and rope	☞ = 25
065059	For (poly) wire and rope	☞ = 75
025527	For (poly) wire and rope	☞ = 125
060788	For (poly) wire and rope	☞ = 250

XDI bolt-on insulator M6x23mm metal



High quality Bolt-on insulator with metal core. The orange ring guarantees an equal distance between the insulator and the conductor. Suitable for (poly) wire or cord on a steel post, like the Termination post (022014/022236). (External thread length 25mm M6 incl. 2xnut, total length 33mm).



057795	For (poly) wire and rope	☞ = 10
079094	For (poly) wire and rope	☞ = 125

Screw-in Insulator Promopack



With metal core. High-quality black plastic. For wooden posts. Suitable for (poly) wire and cord.



071074	Screw-in Insulator in bag	☞ = 100
--------	---------------------------	---------

Screw-in insulator super in bucket (175)



High quality screw-in insulator without metal core, therefore no short circuiting possible. For adding a wire to a wooden fence post. Type 009008 also suitable for 12,5mm tape.



079537	For wire, rope and 12,5mm tape	☞ = 175
--------	--------------------------------	---------



Screw-in insulator wood small



Solid High quality screw-in insulator without metal core, therefore no short circuiting possible. For adding a wire to a wooden fence post.

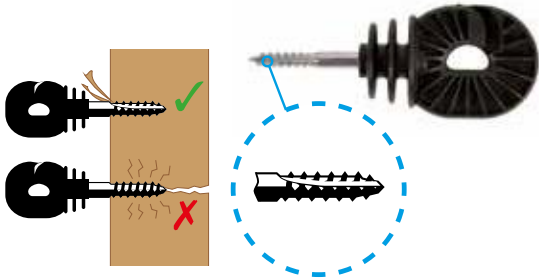

004089	For wire and rope	☞ = 25
040711	For wire and rope	☞ = 125
011193	For wire and rope	☞ = 250
009008	For wire, rope and 12,5mm tape	☞ = 25
040728	For wire, rope and 12,5mm tape	☞ = 100
011209	For wire, rope and 12,5mm tape	☞ = 250

Screw-in insulator wood



Low-priced, high quality screw-in insulator without metal core. Suitable for wooden posts.



060894	For (poly) wire and rope	☞ = 75
--------	--------------------------	--------

Wire clip insulator for Line Post



You need this wire clip if you want to fit fencing wire or cord of up to 8mm (Gallagher EquiFence/permanent cable) to a Line Post. These clips have been developed especially for the Gallagher Line Post.



744346	For wire and rope	☞ = 20
--------	-------------------	--------

Claw Insulator concrete



Insulator for permanent fencing with flat back for stable fitting on a concrete post. Suitable for HT wire and Vidoflex.



709048	For polywire and wire / black	☞ = 25
--------	-------------------------------	--------

W-insulator Small



Made from high density, sunlight resistant polyethylene plastic. Large heavy duty shield eliminates power leakage. Suitable for guiding wire around a corner post.



006734	For polywire and wire / black	☞ = 25
028498	For polywire and wire / black	☞ = 175

W-insulator Super



Made from high density, sunlight resistant polyethylene plastic. Large heavy duty shield eliminates power leakage. Suitable for guiding wire around a corner post.



067612	For rope and Equifence/white	☞ = 25
067617	For rope and Equifence/white	☞ = 175
067605	For rope and Equifence	☞ = 25
021055	For rope and Equifence	☞ = 175

Strain insulator S



Suitable for short strains and semi-permanent short fences. Available in plastic and super strong polycarbonate



011025	For rope and wire / black	☞ = 5
012015	For rope and wire / black	☞ = 100

High Strain insulator Kit with stainless steel rope



Simplest option for end strain insulation. Long life Super Strain Insulator with pre-attached stainless steel rope. Simple install, no wire tying or special tools required. Fits up to 200mm/8" pos

079483	For rope and wire / white	☞ = 5
--------	---------------------------	-------





Corner insulator Extra High Voltage



Designed for high powered fencing systems and areas where insulation is critical. Insulation ribs provide 2 x the insulation performance of previous models to reduce chances of stray voltage around critical areas. Streamlined design allows for comfortable positioning in hand during installation; the wire can be easily cut away for product reuse



100002	For rope and wire / white	☞ = 10
100003	For rope and wire / white	☞ = 100

Porcelain strain/corner insulator



A porcelain End-strain Insulator for high tensions.



015139	For wire	☞ = 6
053506	For wire	☞ = 60

Porcelain corner insulator



A porcelain roll-corner insulator to strain the wires on the corner posts.



015146	For wire	☞ = 6
015141	For wire	☞ = 60

Roller screw-in insulator

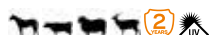

Innovative Gallagher design. Easy to install. Suitable for poly wire and rope. The special design means the wire always returns to the roll.



029013	For polywire and rope	☞ = 5
---------------	-----------------------	-------

Strain insulator S reinforced



Suitable for short strains and semi-permanent short fences. Available in plastic and super strong polycarbonate.



011032	For rope and wire / white	☞ = 5
678023	For rope and wire / black	☞ = 5
012022	For rope and wire / white	☞ = 100
678061	For rope and wire / black	☞ = 100

Roller screw-in insulator



For use with Termination post (022014/022236) or for fixing to a wooden fence post. Only suitable for poly wire.



010707	For polywire	☞ = 5
---------------	--------------	-------

Clips for Insultimber/Ecopost



We recommend the use of Part.No 011056 for fixing wire to an Insultimber post or Gallagher Ecopost. Use Part.No 011063 with 1 metre droppers. You can tighten the clips using the wire twister (part.no 005232).



997025	Long 150mm/Plastic coated	☞ = 50
011056	Short 100mm / for wire	☞ = 25
024698	Short 100mm / for wire	☞ = 1000
011063	Long 150mm / for wire	☞ = 50
024704	Long 150mm / for wire	☞ = 1000

Roller bolt-on insulator



For use with Termination post (022014/022236). Only suitable for poly wire. External thread length 28mm. M8 incl. 2 x nut.



010714	For polywire	☞ = 5
---------------	--------------	-------

PowerLine tape insulator



Insulator used to fix 40mm tape to wooden fence post. Can be stapled, nailed or screwed to post. The tape is very easy to fix.



011094	For up to 40mm tape	☞ = 25
040674	For up to 40mm tape	☞ = 125



TurboLine Horse insulator



Insulator with soft faces to lock the tape between two rubber sleeves (patented system). Fixes the tape with 1 click and prevents wearing guaranteeing a long life for your tape. Additional screw can be used to tighten the insulator even more.

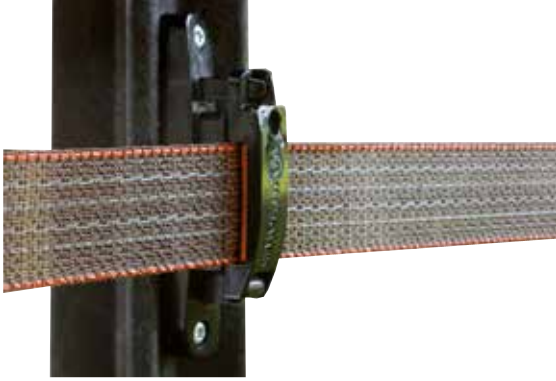

699004	For up to 40mm tape	☞ = 20
699066	For up to 40mm tape	☞ = 100

TurboLine Horse corner/strain insulator



The new very innovative robust Corner Insulator. Has a lot of advantages compared to the traditional insulators. A unique sub frame for optimal strength and fixation at the post. Pre mounted rubber grip for best tape fixation. Can be installed with only one drill bit. A unique slot to strain and re-strain your tape. The optional metal plate (art. 708027) can be used as a tape connector and gate anchor.



701028	For up to 40mm tape	☞ = 5
701042	For up to 40mm tape	☞ = 30
708027	For 40mm tape / gate anchor	☞ = 5

TurboLine tape insulator



Insulator with soft faces to lock the tape between two rubber sleeves (patented system) to prevent the wear off guaranteeing a long life for your tape.

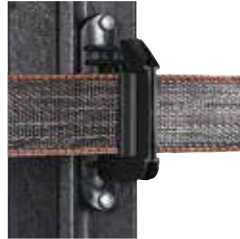

011087	For up to 40mm tape	☞ = 20
021482	For up to 40mm tape	☞ = 100

TurboLine corner/strain insulator



Corner insulator in high quality plastic which secures the tape between 2 rubber sleeves (patented system), guaranteeing long life for your tape. Use the connecting plate (Part No. 010745) for end (gate) posts to ensure good connection between the tapes.



016702	For up to 40mm tape	☞ = 5
043880	For up to 40mm tape	☞ = 30
010745	For 20/40mm tape	☞ = 5

TurboLine Line Post tape clip



Fast install, easy to use no tools required. Positive locking and quick release to enable re-tensioning of tape. Soft rubber pads lock tape in place to prevent tape movement and fraying.



747033	For up to 40mm tape	☞ = 12
---------------	---------------------	--------

XDI offset bolt-on insulator metal 20cm/M6



Innovative Gallagher design. Much stronger than the standard offset insulator due to a new technique, and more durable due to its metal core. The chance of short-circuits is zero. The orange plastic section serves as a wear indicator. (Total length 200mm, external thread length 125mm M6 incl. 2xnut/washer).



029006	For (poly) wire and rope	☞ = 10
---------------	--------------------------	--------

XDI offset screw-in insulator wood 10cm



Innovative design. Much stronger than the standard offset screw-in insulator thanks to a new technique. More durable thanks to its metal core. The orange plastic section serves as a wear indicator. To be used with wooden posts. Distance 18cm.



075904	For (poly) wire and rope	☞ = 20
077274	For (poly) wire and rope	☞ = 100



XDI offset screw-in insulator wood 18cm



Innovative design. Much stronger than the standard offset screw-in insulator thanks to a new technique. More durable thanks to its metal core. The chance of short-circuits is zero. The orange plastic section serves as a wear indicator. To be used with wooden posts. Distance 18cm.



028993	For (poly) wire and rope	☞ = 10
042647	For (poly) wire and rope	☞ = 100

XDI offset screw-in insulator wood bended 18cm



High quality offset insulator (18cm) with metal core, helps prevent damage to non-electric fences. The orange ring guarantees an equal distance between the insulator and the conductor. Suitable for (poly) wire or cord.

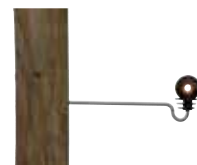

057801	For (poly) wire and rope	☞ = 10
057818	For (poly) wire and rope	☞ = 100

Offset screw-in insulator wood 10cm



Solid high quality offset screw-in insulator (10cm) for wooden posts. Without metal core. Suitable for (poly) wire and cord.



072491	For (poly) wire and rope	☞ = 20
--------	--------------------------	--------

Fence Insulator for pos/neg system



This insulator has been developed especially for fitting on a spacer insulator (item 072491 or 029006). With this combination you can quickly and easily create a plus-minus fencing on your fence to keep cats out or in your garden.



077335	For polywire	☞ = 30
--------	--------------	--------

Offset screw-in insulator 20cm



For electrifying non-electric fences quickly and effectively. Distance 20cm. With insulator suitable for wire and rope up to 9mm.



009350	For polywire and rope	☞ = 10
--------	-----------------------	--------

Live Tip offset insulator steel post 16cm



With an electrified tip and zero leakage through the post, the live tip offsets are an effective, new option for protecting existing fences. 10 year product warranty.



006145	For wire and rope	☞ = 20
--------	-------------------	--------

Offset Pigtail insulator wood 17,5cm



For electrifying specific existing non-live fences quickly. Available in 2 lengths: 17.5cm or 40cm. Very suitable for rope and tape. Pre-drill hole and staple the offset to the wooden post.



010981	For wire and rope / white	☞ = 10
720234	For wire and rope / terra	☞ = 10
010998	For wire and rope / white	☞ = 10
720135	For wire and rope / terra	☞ = 10

Top mount double end Ring Top offset 80cm



With this double-sided offset insulator Ring Top, you can separate adjacent pastures and each fencing has its own current. It means the animals cannot get close.

NEW



Live Tip offset insulator wood 16cm



With an electrified tip and zero leakage through the post, the live tip offsets are an effective, new option for protecting existing fences. 10 year product warranty.



006183	For wire and rope	☞ = 20
006190	For wire and rope	☞ = 20

751528	For wire and rope / white	☞ = 5
--------	---------------------------	-------



Offset bolt-on insulator 20cm/M6

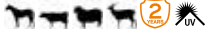

For electrifying non-electric fences quickly and effectively. Distance 20cm. With insulator suitable for wire and rope up to 9mm. To be used with steel posts. (External thread length 110mm M6 incl. 2xnut).



007516 For polywire and rope = 10

Offset Pinlock Insulator wire 30cm



For electrifying existing or run down fences. Easy to fix. 30cm long. Large spark guard. Pin lock for easy installation and removal of wires.



659046 For polywire / black = 25

Offset Chainlink Insulator chainlink 30cm



For protecting and electrifying chain link netting. The completely galvanized clips are easy to fit to any type of netting. Pin lock insulator makes fixing the wire easy. 32cm long.

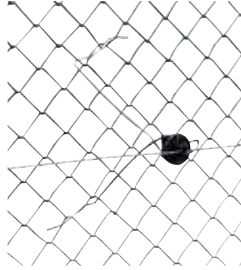

010912 For polywire / black = 25

Clip Fibreglass post 10mm



Easy to use stainless steel clips for adding an extra wire to the Gallagher Fibre glass post \varnothing 10mm.



018300 For 10mm Fibreglass post / inox = 25

Mounting bracket 40/60mm



Mounting bracket. Fits on every garden wire enclosure. Incl. a connection point (M6 and M8) for insulator 010714/057795/007516 to also protect your garden wire enclosure. Fitted with a rubber insert to prevent damage to the post.



008780 Supports M6 and M8 = 5

Click-on insulator



Adjustable insulator for Spring steel Post (art. 008902/019274).



010752 For Spring steel post = 10

Screw-on rod insulator open version



For adding extra wire to round portable posts. Ideal for steel pigtail posts.



010950 For 4/10mm post / black = 20

010936 For 6/14mm post / green = 20

011230 For 6/14mm post / green = 250

010943 For 6/16mm post / white = 10

Clip stainless steel



Easy to use stainless steel clips for adding an extra wire to the Gallagher pvc post 13mm.



003266 Clip for Plastic post 13mm = 10

063499 Clips for Deer post 19mm = 25



CONNECTORS

Connectors are crucial in electric fencing. They are relatively small parts, but essential to proper current conductivity. Knotting wire together produces a loss of power, rendering the fencing ineffective. Fitting a good connector represents a minor investment, but you do have perfect fencing!



Vidoflex connector



This stainless steel clamp provides a good conductive connection between polywire. Easy to use.



060764 Vidoflex connector = 4

Rope connector with wingnut



This stainless steel clamp provides a good conductive connection between Rope or Vidoflex.



075928 Rope connector with wingnut = 4

Rope connector



This stainless steel clamp provides a good conductive connection between Rope or Vidoflex.



019342 Rope connector = 4

071159 Rope connector = 25

Joint clamp



Essential for ensuring there is no loss of conductivity at connections. Effective animal control is dependant on optimum conductivity around the power fence. Heavily galvanized for durability and long life. Suitable for all size wire and rope.



010851 Bobbin round with hex nut = 10

603568 Bobbin round with hex nut = 100

Joint clamp angle



Essential for ensuring there is no loss of conductivity at connections. Effective animal control is dependant on optimum conductivity around the power fence. Heavily galvanized for durability and long life. Suitable for all size wire and rope.



010868 Angle with wingnut = 10

603964 Angle with wingnut = 100

060498 Angle with hex nut = 100

Tape joiner



Innovative Gallagher design. For connecting and tensioning tape up to 20mm. Easy to install using the rucksack clasp principle. Now it is easy to connect tension and release tape.



028979 For 12,5/20mm tape = 5

028962 For 20/40mm tape = 5



Tape joiner



To be used in combination with part no. 016702 or for joining and/or connect 20/40mm tape. Gives excellent mechanical and electrical connection. Made from non-rusting stainless steel.



010745 For 20/40mm tape  = 5

Tape connector



Double connector for connecting two rows of tape. Length cable: 60cm.

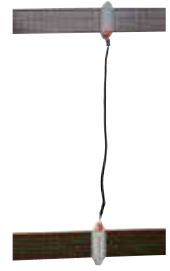

055333 Tape / tape connector 60cm  = 1

Tape connector



Single connector for perfect connection from the energizer to the tape fence line. Length cable: 130cm.



055340 Tape / energizer connector  = 1

Insulated End Strainer

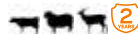

Kit to easily tension Equiwire or High Tensile using a socket, fork spanner or a tensioner (695303). Eliminates the need for wire knots. May be used on all Gallagher wooden posts. Includes 2 tensioners.



618005 With fastening cable  = 2

695303 Handle for tensioner  = 1

Clip lock strainer



Clip lock strainers can be placed in the fence line during or after building your fence. For easy straining and re-straining your wires.



056095 Clip lock strainer  = 2

695303 Handle for tensioner  = 1

Rope tensioner



For easy tensioning of rope. Easy release thumb catch. For use in combination with the roller screw-in insulator. (# 029013) or the strain insulator (# 011025/011032). Comes as standard with a roller screw-in insulator.



028955 Rope tensioner  = 1

Tension spring



The tension spring neutralises the tension difference in the wire which is caused by fluctuations in temperature. It keeps the wire evenly tensioned during summer and winter, which means you can double (up to 15m) the distance between the posts. Suitable for 1.6mm and 1.8mm HT wire. Maximum tension strength 85kg. Stainless steel, length spring 155mm, Productwarranty 10 Year.

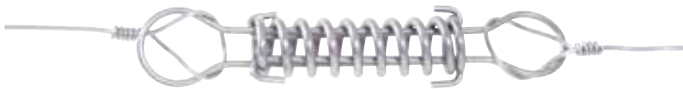

004133 For HT \varnothing 1,6mm/1,8mm  = 1

Tension spring



The tension spring neutralises the tension difference in the wire which is caused by fluctuations in temperature. It keeps the wire evenly tensioned during summer and winter, which means you can double (up to 15m) the distance between the posts. Suitable for 2.5mm and 2.65mm HT wire and EquiFence. Maximum tension strength 200kg. Stainless steel, length spring 345mm, Productwarranty 10 Year.



036257 For HT/EQ \varnothing 2,5mm/2,65mm  = 1

Wire tensioner



Use of this unique tensioner means that the wire does not have to be cut to strain it. Consequently, the power in the wire will be uninterrupted. Strong, lightweight, rust resistant construction. Can be used to join wires. Also suitable for rope. Excl. Wiretensioner (029044 or 006451).

010882 Wire tensioner  = 3

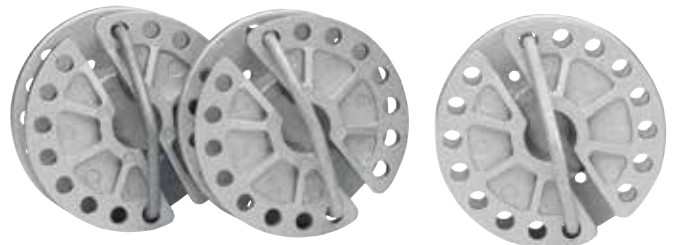

021475 Wire tensioner  = 25



GATES

Gallagher has several options for making a gate. Are you familiar with the Gallagher multi-wire gate set? They are ideal! It allows you to open and close the gate with one hand.

We also have a tough electric gate for permanent fencing.



Multi strand gate kit



The most complete and easy to use all-in-one multi strain electric gate on the market. Provides a low cost gate solution for practically any width gateway. Comes with 40mm tape.

Electrified steel gate



Adjustable, maintenance free gate, fully electrified. Suitable for all permanent fences incl. tape. Will fit gates from 2.5m to 4.5m. Height: 1.0m.



718842	4x 40mm tape terra / 6m	☞ = 1
718040	4x 12,5mm tape white / 6m	☞ = 1
718026	2x 12,5mm tape white / 8m	☞ = 1



001064	Gate width 2,5m up to 4,5m	☞ = 1
--------	----------------------------	-------

Drive thru Electro gate



A complete gate which can be erected anywhere where you have to drive frequently through a gate. Vehicles can push the gate open and the spring loaded gate closes automatically.

Batt-Latch Gate Release Timer



Automatic gate opener, including self-closing gate spring. This system is ideal for opening a gate at a pre-set time. Extremely suitable for dairy farming and strip grazing. The system works on a battery with support from solar panels, ensuring the battery lasts longer.



004164	Gate width 3,7m	☞ = 1
054923	Gate width 5,0m	☞ = 1



007441	Automatic gate release	☞ = 1
--------	------------------------	-------



016412
Elastic rope gate



640556
Elastic rope gate



009084
Spring gate



016405
Spring gate white



054954
Retractable auto reel terra



010844
Retractable auto reel white

Elastic rope gate set



Complete gate set (conductive cord, white), to quickly and easily create a passage in a (cord) fence. Easy to open and close by pick up the gate handle in or out of the included gate handle anchor. Suitable for gate passages starting from 3 up to 6 meters wide.



016412 Gate width 3 up to 6m / white ☞ = 1
072354 Gate width 3 up to 6m / terra ☞ = 1

Elastic rope gate set / 2 gate handles



Set to create a gate using elastic conductive rope (white). This rope with a length of 6½m can be stretched to create a gate of up to 11m. Fence can be opened from either end. Includes 2 gate handles attached to the elastic rope and 2 unique Gallagher gatehandle anchors.



640556 Gate width 6,5 up to 11m / white ☞ = 1



Spring gate set



Adaptable, gate closure. Complete set, maximum width 5 m. Not recommended for use with horses.



- 009084** Gate width 5m ☞ = 1
- 016405** Gate width 5m / white spring ☞ = 1

Retractable auto reel



Gate system with retractable reel, it automatically rolls and unrolls a walk way up to 1.5m. Simple to install and easy to handle. Comes complete with gate handle and multi directional mounting bracket. Available in white and terra.



- 010844** Gate width 1.5m / tape 40mm white ☞ = 1
- 054954** Gate width 1.5m / tape 40mm terra ☞ = 1

Dual Purpose Portable handle

The new Dual Purpose Handle provides the flexibility with extra secure connection points, enables farmers to liven the fence from either the reel or handle end. By tying a loop in the wire, tape or braid it can be attached easily to the eye in the handle. "Ring Top" design connection hook ensures that the handle will not bounce off the fence wire. The moulded hand grips indicate where to place hands to avoid getting a shock. The handle is made from durable UV resistant material.



- 738321** Dual purpose handle ☞ = 6

Insulated Portable handle

Using the innovative Ring Top Post design connection hook ensures that the handle will not bounce off the fence wire. And the design provides an easy retrieval through pasture when winding in. The moulded hand grips indicate where to place hands to avoid getting a shock. The handle is made from durable UV resistant material.



- 737324** Portable handle for reel ☞ = 6

Soft touch gate handle



New strong gate handle in orange with black rubber accents for an optimal grip and excellent visibility. 697000 for cord or wire, 696003 with tape buckle 40mm.



- 697000** For rope and wire / orange / Inox ☞ = 1
- 055722** For rope and wire / orange / Inox ☞ = 4
- 057979** For rope and wire / terra / Inox ☞ = 1
- 058198** For rope and wire / terra / Inox ☞ = 4

Soft touch gate handle



New strong gate handle in orange with black rubber accents for an optimal grip and excellent visibility. 697000 for cord or wire, 696003 with tape buckle 40mm.



- 696003** For tape / orange / Inox ☞ = 1
- 055715** For tape / orange / Inox ☞ = 4
- 057986** For tape / terra / Inox ☞ = 1
- 058204** For tape / terra / Inox ☞ = 4



Gate handle



Heavy duty, durable gate handles in black and orange. Good visibility and large protective shields. 007585 has a compression hook for easy use. 010769 for attaching tape to a gate handle.

010776	Basic gate handle / orange	☞ = 1
010783	Basic gate handle / black	☞ = 1
007585	Gate handle with N-hook / black	☞ = 1
010769	Gate break joiner for 40mm tape	☞ = 4



Compression gate handle



Gate handle with compression hook for easy use.



072408	Gate handle with N-hook / black	☞ = 10
--------	---------------------------------	--------

Gate handle anchor



For connecting a gate handle, with galvanized joining plate. We recommend the use of wire clamp (part no. 010851) to guarantee an optimum connection.



010905	2-way / screw-in	☞ = 4
--------	------------------	-------

Gate handle anchor



Gate anchor with 3 anchor points for Gallagher gate handles, ideal in multi-paddock situations. Power connects to bolt from below the plate. Comes with the 3mm galvanized plate.



021451	3-way / screw-on with leadout conn	☞ = 4
--------	------------------------------------	-------

Gate handle anchor

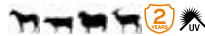

Innovative Gallagher design. For attaching a gate handle. Stronger than all other gate handle anchors thanks to the new technique. Made of high-quality materials. Includes connector option for 1,6mm earth cable.



028986	2-way / screw-in with leadout conn	☞ = 5
--------	------------------------------------	-------

Gate handle anchor



Innovative Gallagher design. Anchor to attach a gate handle to steel posts. Stronger than all other gate handle anchors thanks to the new technique. Made of high quality materials.



060658	Bolt-on with leadout conn	☞ = 5
--------	---------------------------	-------

Gate handle anchor



For connecting a gate handle.



010738	2-way / screw-in / basic	☞ = 4
--------	--------------------------	-------



EARTHING

Earthing ensures that the current can flow back to the energizer as soon as an animal touches the fence. No earthing means no current on the fencing, which is essential to good fencing!



Bentonite

Earthing can be achieved simply and quickly with this mix, even in extremely dry conditions. The mixture of salt and absorbent clay retains moisture and increases the conductivity of the surrounding soil. To be used in poor earthing conditions and in combination with more powerful energizers. Excl. earth stake.



008773 Super earthing mix (6kg) ☞ = 1

Lead out cable XL

10

XL wire coated with a heavy duty double insulation. Good quality polyethylene for abrasion resistance in the ground. 2,5mm medium tensile aluminium coated wire 4 times the conductivity of 2,5mm galvanized wire. Ideal for carrying power long distances underground. For use between earth stakes.



016276 2,5mmXL-200m-80hm/km ☞ = 1

Lead out cable

2

Double insulated lead-out cable to connect the energizer with the fence and to make underground connections (e.g. gateways). Use this cable for short distances. For distances over 30m use 2.5mm cable.



065028	1,6mm - 10m - 100 Ohm/km	☞ = 1
066097	1,6mm - 25m - 100 Ohm/km	☞ = 1
021604	1,6mm - 50m - 100 Ohm/km	☞ = 1
065011	2,5mm - 25m - 35 Ohm/km	☞ = 1
062712	2,5mm - 50m - 35 Ohm/km	☞ = 1
021611	2,5mm - 100m - 35 Ohm/km	☞ = 1
162713	2,5mm - 400m - 35 Ohm/km	☞ = 1

Earth stake

2

Without a proper Earth System your energizer will not perform. Always use galvanised earth stakes. Battery Energizers: Earth Stake length 1m c/w clamp.



029037	2m with earth clamp	☞ = 3
029020	1m with earth clamp	☞ = 3
008735	1m without earth clamp	☞ = 1
044030	Earth clamp	☞ = 1

Earthing accessories

2

Earth clamp: guarantees a good connection between the earth stakes and lead-out cable from the energizer. Lead out joint kit: for a secure, waterproof connection of lead out cable without power loss.



044030	Earth clamp	☞ = 1
063796	Lead-out connector	☞ = 2
044023	Earth socket	☞ = 1



REELS AND TOOLS

Reels are used for portable fencing to wind or unwind the fencing wire. It can be fixed with the reel corner post to produce a strong construction.

If you are going to put up electric fencing you simply need the right tools. Whether you need to tension High Tensile fencing, cut wire, or screw down insulators, the job is simple when you use Gallagher tools.

Reel 200m



Low cost convenient plastic reel with ratchet for 200 metres of polywire.



008933 Reel 200m

🌀 = 1

Reel 400m

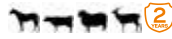

Convenient plastic reel with ratchet for 400 metres of polywire. Detachable drum.



008919 Reel 400m

🌀 = 1

009145 Spare drum for reel 400m

🌀 = 1

Econoreel 500m



A strong and durable reel with ratchet mechanism for winding up and unwinding polywire. Suitable for up to 500m polywire. Equipped with insulated handle. Hooks directly to fence or use Reel Stand.



046167 Econoreel 500m

🌀 = 1

Geared reel 500m

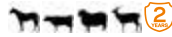

Equipped with an accelerator mechanism so the drum rotates three times faster than standard reels. Carry handle with knuckle guard. Locking ratchet. Long crank arm for better leverage. Wire loop for connecting power to wire/tape. Holds up to 500 metres of polywire or 200 metres of tape. Attachable to Reel Stand.



061139 Geared reel 500m

🌀 = 1

061115 Medium reel 500m

🌀 = 1

SPECIFICATIONS REELS

	Vidoflex 9 / 12 TurboLine Plus	Vidoflex 6	Vidoflex 3	Cord	TurboLine tape 40mm	TurboLine tape 20mm	TurboLine tape 12.5mm
Reel 500m 061139	400m	500m	500m	200m	100m	150m	200m
Reel 500m 061115	400m	500m	500m	200m	100m	150m	200m
Econo reel 046167	400m	400m	500m	150m	100m	100m	150m
Reel 400m 008919	250m	400m	400m	-	-	-	-
Reel 200m 008933	150-200m	200m	200m	-	-	-	-
Reel 1200m 016313	1000-1100m	1200m	1200m	400m	200m	200m	400m



Large geared reel 1200m



Heavy duty gearbox for easy winding, fast wind in (2.7:1). Large comfortable hand grip with knuckle guard for safer use. Holds: 400m 12.5mm TurboLine tape, 400m 12,5mm PowerLine tape, 1000m Vidoflex 9 or 1200m Vidoflex 6.



016313 Large geared reel 1200m = 1

Triple Geared Reel Stand pre-installed



Triple Geared Reel Stand with 4.0m Vidoflex polywire. Pre-assembled with post and three pre-wound Geared Reels (061139).

Post height 1070mm and reels are pre-wound with 400m Vidoflex polywire. Suitable for containing all types of animals. Multi reel connector (006345) available separately.



633046 Incl. 3 Geared reel and rope = 1

Reel/Termination post



Reel/Termination post for portable fences. Holds up to three grazing reels or insulators. Galvanized steel Tread-in foot peg. Add the support bracket for additional structural support.

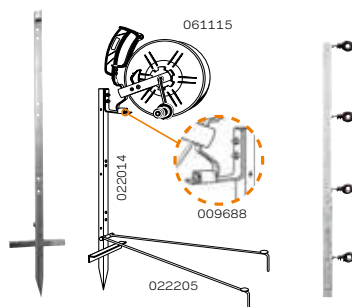

022014 Supports 3 reels/insulators - 1,25m = 1

022236 Supports 4 reels/insulators - 1,85m = 1

009688 Reel bracket = 4

022205 Support leg = 1

Multi reel connector set

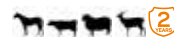

Insulated lead for connecting power to multi reel system. UV resistant insulated plastic clips. Stainless steel jaws for long life.



006345 Multi reel connector set = 1

Wire dispenser

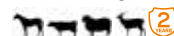

Ideal for running out or winding up all types of wire. Fully galvanized for long life. Easy to use.



011018 For fencing wire = 1

Farmer pliers



004140 Farmer pliers = 1

Gallagher pliers



005225 Gallagher pliers = 1

Wire twister

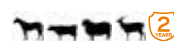

With this wire twister, you can twist the wire clips around a wire without a problem. Ideal for use with Insultimber/Ecopost fences.



005232 Wire twister = 1



Drill chuck Basic



Support to easy mount almost the entire range of Gallagher ring and screw insulators with your battery drill. (Not suitable for 057801, 057818, 009350 and Screw-in Insulator Super)



053933 Drill chuck Basic = 1

Post holer 75mm



Low cost and easy to use tool for installing soft wood posts. Using the postholer makes fencing easy and prevents the post from getting damaged when using a sledge hammer. Two diameters.



704644 For 75mm posts = 1

704668 For 100mm posts = 1

Drill chuck Pro



Support to easy mount almost the entire range of Gallagher ring and screw insulators with your battery drill. (Not suitable for 057801, 057818 and 009350)



077397 Drill chuck Pro = 1

Screw-in Tie Down

The Screw-in Tie Down anchors the Line Post to the ground in surfaces with hills and hollows. Fast and easy to install, using the handle for the screw in tie down. (SKU:006161)



106151 Screw-in Tie Down = 5

006161 Handle for Screw-in Tie Down = 1

Rammer



Indispensable for driving Insultimber posts to correct depths without damaging posts. Prevents posts from standing out of line.



035311 For Insultimber posts = 1

017652 For Eco posts = 1

017614 Sledge hammer = 1

Rammer



Special rammer for convenient hammering in of a Gallagher Line post.



525013 Line Post Rammer = 1

530031 Sleeve for Line Post Rammer = 1

540016 Line Post Pilot = 1

Line Post Accessories



Line Post Post lifter to easily pull out the Gallagher Line Post. Handy tool designed specifically for the Gallagher Line Post.



527017 Line Post Lifter Adapter = 1

Universal post Lifter



Post Lifter, suitable for the Line Post lifter adapter To easily pull out the Gallagher Line Post.



527000 Universal Post Lifter = 1

Wire tensioner



Tool for installing ratchet tensioners in fencing.



029044 Wire tensioner basic = 1

006451 Wire tensioner pro = 1

Gallagher Screws

Self drilling torx screws 4,5x40 with cylinder head. The special red wax layer makes pre-drilling unnecessary. T25 Screw bit included.



050000 4,5x40 T25 (200) = 200



POSTS

Gallagher has two types of posts - posts for temporary fencing and posts for permanent fencing. The permanent posts - Gallagher post, Ecopost and Insultimber post - differ from each other in terms of quality, sustainability and price. We also have portable posts in various types and sizes, including plastic posts, fibre-glass posts and metal posts. Each type has its own application.



Insultimber (FSC®)



Unique insulating posts where the use of insulators isn't necessary. Maintenance free. Long life time. 10 years guarantee.

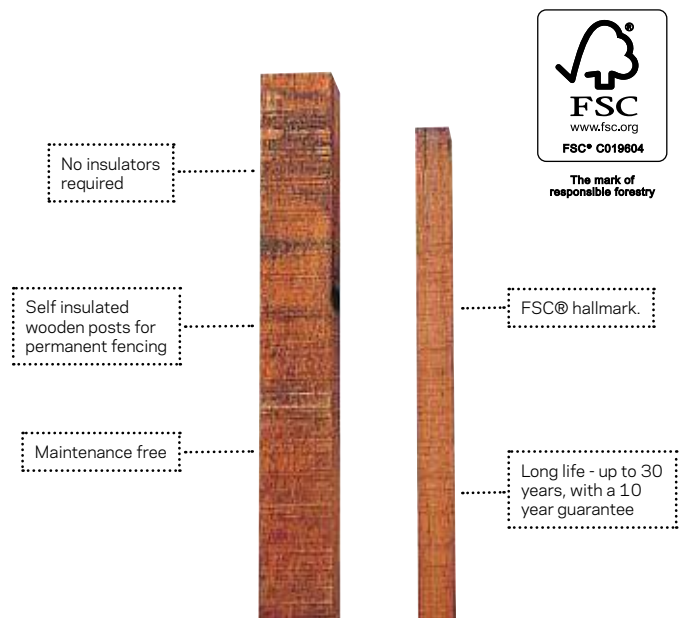

017898	Strainer post 200x8x8cm	☞ = 1
017997	Strut 200x4x8cm	☞ = 1
007847	Post 210x5x5cm	☞ = 1
007724	Post 180x3,8x3,8cm	☞ = 1
007601	Post 150x3,8x3,8cm	☞ = 1
007854	Dropper 156x3,8x2,6cm	☞ = 1
007733	Dropper 126x3,8x2,6cm	☞ = 1
019403	Dropper 110x3,8x2,6cm	☞ = 1
007618	Dropper 95x3,8x2,6cm	☞ = 1



Eco post



Plastic Eco Post, made from 100% single source, recycled material (polypropylene). The material together with the cross-shaped section (Ø 70mm), guarantees the strength of the post. No insulators needed. Up to 70% more cost effective than traditional (non-electric) fencing.

009527	Black - 150x7cm	☞ = 4
009534	Black - 185x7cm	☞ = 4



AWARD WINNER - THE INSULATED LINE POST



Gallagher Insulated Line Post



Gallagher Insulated Line Post (1.50m), unique and durable design and extremely suitable for permanent fencing. Full self-insulating and extremely quick and easy to set up. The conductor can be attached to various pre-shaped positions with LinePost Clips that are available separately. Product warranty: 10 years. Lifespan: 25 years or more!



742335	Insulated Line Post 1,50m	☞ = 10
742212	Insulated Line Post 1,35m	☞ = 4
742014	Insulated Line Post 0,95m	☞ = 4

Gallagher Insulated Line Post Dropper 0,95m



The Line Post Dropper is a floating post that keeps the fencing between two posts at the right height and properly tensioned. Instead of three posts over 12 metres of fencing, you only need two posts if the Dropper is used. A Dropper is cheaper than a Line Post, which cuts the total fencing costs.

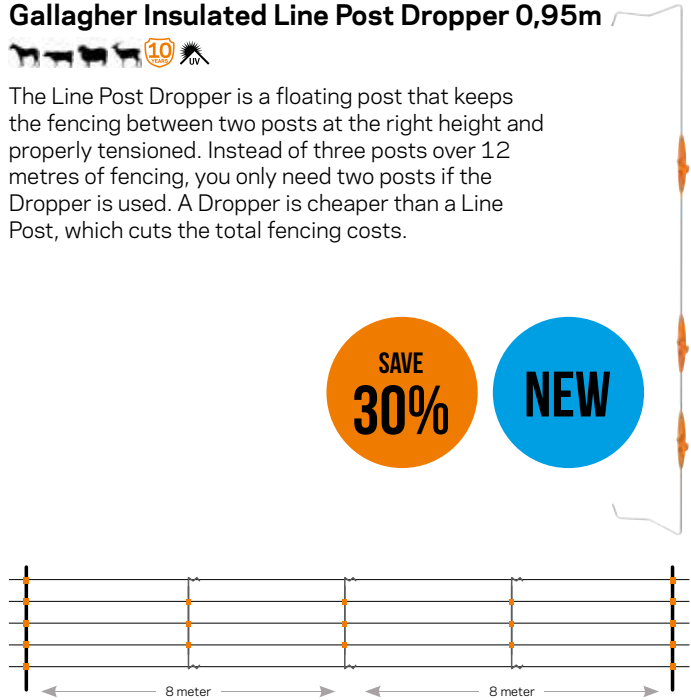

717135	Insulated Line Post Dropper	☞ = 10
--------	-----------------------------	--------

Wire clip insulator for Line Post



You need this wire clip if you want to fit fencing wire or cord of up to 8mm (Gallagher EquiFence/permanent cable) to a Line Post. These clips have been developed especially for the Gallagher Line Post.



744346	For wire and rope	☞ = 20
--------	-------------------	--------

TurboLine Line Post tape clip



Fast install, easy to use no tools required. Positive locking and quick release to enable re-tensioning of tape. Soft rubber pads lock tape in place to prevent tape movement and fraying.



747033	For up to 40mm tape	☞ = 12
--------	---------------------	--------



SUPER-EFFICIENT FENCING SOLUTION

My search for a durable, simple but proper solution for my fencing brought me to the Line Post in April this year. Now I can't stop going on about it!

Convenience

I erected the fencing together with the dealer, but it was so simple I could have done it on my own; that was never possible with my wooden fencing. The usage and installation convenience saves costs too - I need fewer posts, which is what I wanted, so mowing is easier. I can also move and reuse the posts myself, without needing help.

Strong and flexible

If I accidentally hit a post during mowing with my previous fence, that was the end of post. A Line Post can take a knock, bends and simply stays intact, perfect! I imagine that this flexibility is safer for animals too. Finally, a Line Post is extremely thin and doesn't disrupt the view.

Easy to modify

Although it is permanent fencing, it is easy to modify. That's possibly the biggest benefit of all. I just click more wires onto it that can be put at any height with the convenient clips. Ideal if you need to change the types of animals inside the fencing!

*Jonny Davison
Farmer*



Screw-in Tie Down

The Screw-in Tie Down anchors the Line Post to the ground in surfaces with hills and hollows. Fast and easy to install, using the handle for the screw in tie down. (SKU:006161)



106151	Screw-in Tie Down	☞ = 5
006161	Handle for Screw-in Tie Down	☞ = 1

Rammer



Special rammer for convenient hammering in of a Gallagher Line post.



525013	Line Post Rammer	☞ = 1
---------------	------------------	-------

Line Post Accessories



Line Post Auger to easily place Gallagher Line Posts in hard ground. Handy tool designed specifically for the Gallagher Line Post.



540016	Line Post Pilot	☞ = 1
---------------	-----------------	-------

Line Post Accessories



Sleeve for Line Post rammer 1350mm.



530031	Sleeve for Line Post Rammer	☞ = 1
---------------	-----------------------------	-------

Universal post Lifter



Post Lifter, suitable for the Line Post lifter adapter To easily pull out the Gallagher Line Post.



527000	Universal Post Lifter	☞ = 1
527017	Line Post Lifter Adapter	☞ = 1



A PORTABLE POST FOR ANY SITUATION!

Light and easy to move

Gallagher also has portable posts in various types and sizes, including plastic posts, fibreglass posts and metal posts. They are all light-weight and easy to move. For example, we have plastic posts with wire holders so you do not need any loose insulators. The tread-in post has been developed specifically for portable horse fencing. You can take 50 of these smoothly finished posts in one hand when you fence off your pasture. You already know the spring steel post with pigtail insulator.

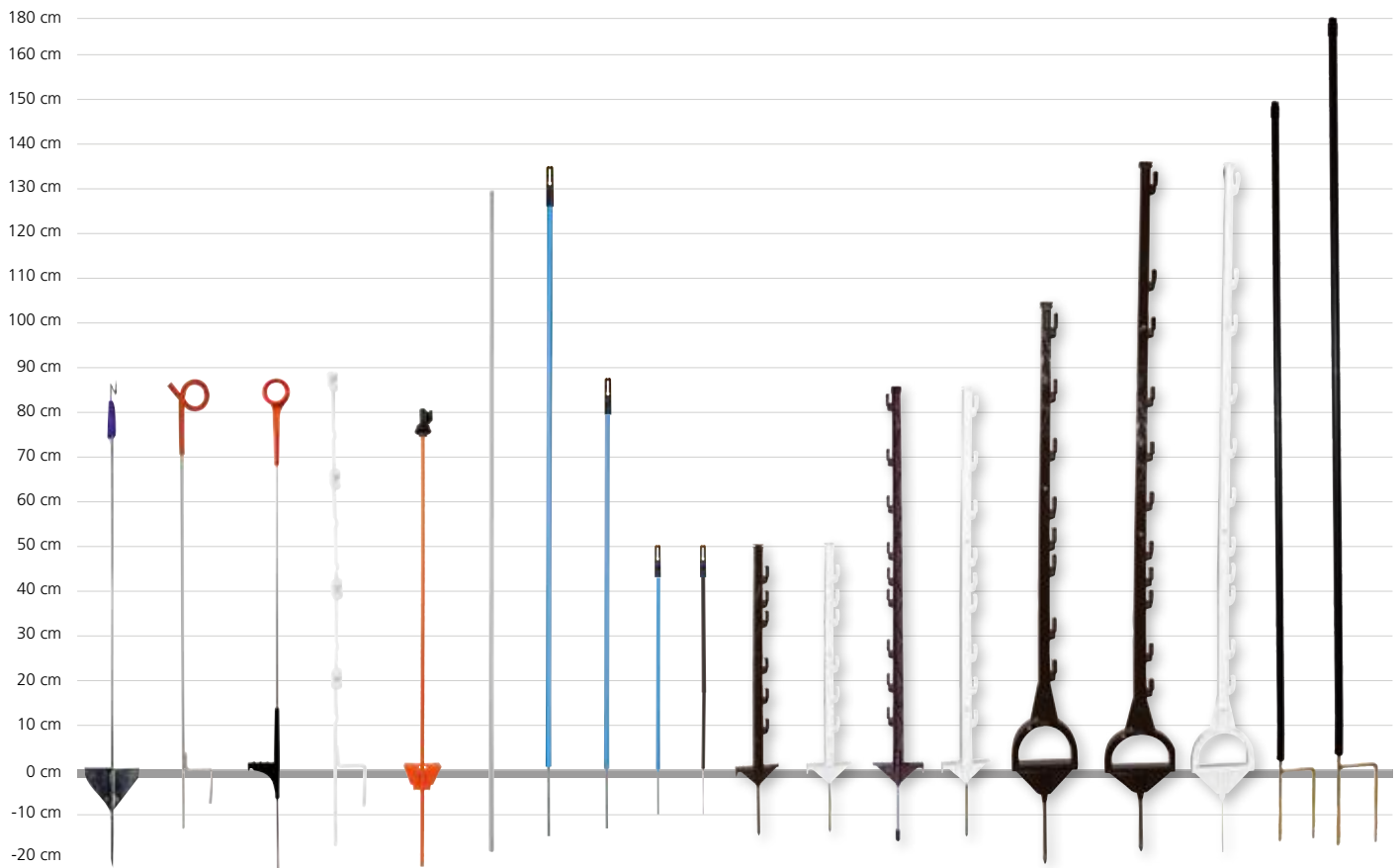

Ring Top post



The most popular option for dairy and beef cattle, practical design for stronger posts, no tangling and better grip in the ground.



723136 Orange - 1,00m

☞ = 10

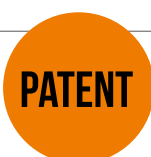

Super tough overmoulded GF nylon head eliminates shorting and prevents wearing through

Easy to use and install even in hard ground.

Long insulation sections strengthen shaft and provide insulation when handling to prevent shocks

Tough unbendable foot plate can withstand 200kg of pressure

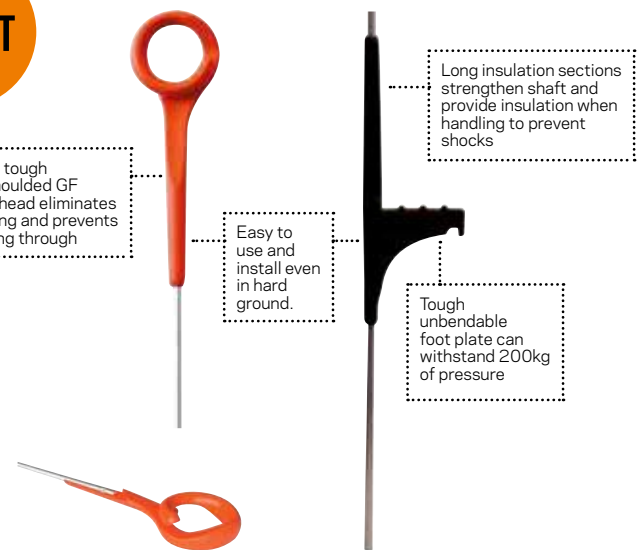



Pigtail post



Plastic coated spring steel post with UV stabilised plastic insulated orange pigtail insulator. If several wires are to be used, add screw-on insulator part no. 010950/010943. Maximum fence height: 0.85m.



- 642134** Orange - 1,00m ⚙ = 10
- 010943** For 6/16mm post / white ⚙ = 10

Hobby post



Very sturdy and durable post, 0.75m high, with 6 numbered lugs. Suitable for tape up to 20mm, rope and polywire. The unique twist 'n lock system guarantees a simple and secure attachment of the conductors with a maximum wire height of 50cm.



- 057849** White - 0,75m ⚙ = 10
- 021468** Terra - 0,75m ⚙ = 10

Vario post / Heavy duty tread in post



Very sturdy and durable plastic post 1.00m high with 9 numbered lugs designed for virtually all kinds of animals. Suitable for all sorts of (poly)wire and tape up to 20mm. The unique twist 'n lock system guarantees a simple and secure attachment of the conductors with a maximum wire height of 0.85m.



YouTube GALLAGHER TWIST AND LOCK

- 028481** White - 1,00m ⚙ = 10
- 071043** Terra - 1,00m ⚙ = 10

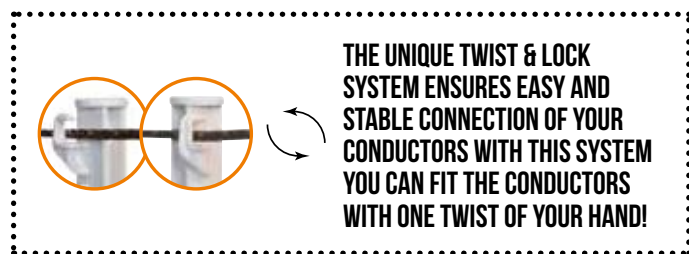

Horse post



Unique and durable post, 1.55m high, which is ideal for semi-permanent horse fencing. Easy to tread by using the convenient stirrup foot. The unique twist 'n lock system guarantees a simple and secure attachment of the conductors up to 1.35m high.

- 019328** White - 1,55m ⚙ = 5
- 061303** Duopack White - 1,55m (2x5) ⚙ = 10
- 060771** Terra - 1,55m ⚙ = 5
- 061310** Duopack Terra - 1,55m (2x5) ⚙ = 10
- 077304** Terra - 1,05m ⚙ = 10





Spring steel pigtail post

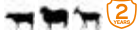

Strong mild-steel post with blue top-insulator and large welded on foot for easy tread-in installation. Use part 004218 or 010950 if you use more wires. Maximum fence height: 0.88m.



019250	Steel - 1,10m	☞ = 10
008155	Top insulator for Spring steel pigtail post	☞ = 5
004218	Schroefisolator (ø12,5mm)	☞ = 10
010950	For 4/10mm post / black	☞ = 20

Spring steel post

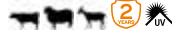

Sturdy steel post. If several wires are to be used, add insulator # 010752. Maximum fence height: 0.80m.



008902	Orange - 1,00m	☞ = 1
019274	Orange - 1,00m	☞ = 50
009411	Spare topinsulator for spring steel post	☞ = 5
010752	For Spring steel post	☞ = 10

Fibreglass post



Fibreglass post ø10mm for semi-permanent fences. Ideal in combination with polywire or 1,6mm High Tensile wire. Please use fibreglass clip 018300 (25) as wireholders.



008172	Fibreglass 10mm - 1,50m	☞ = 1
008158	Fibreglass 10mm - 1,25m	☞ = 50
018300	For 10mm Fibreglass post / inox	☞ = 25

Plastic post



Very practical and simple grazing post. Unique top insulator which is resistant to damage if you knock the post into the ground with a hammer.



024391	Blue - 13mm - 0,70m	☞ = 10
024407	Black - 13mm - 0,70m	☞ = 10
024414	Blue - 13mm - 1,00m	☞ = 10
024421	Blue - 13mm - 1,50m	☞ = 10
2211	Top insulator for PVC post	☞ = 1
003266	Clip for Plastic post 13mm	☞ = 10
004218	Schroefisolator (ø12,5mm)	☞ = 10

Fibreglass Driver Caps



Non-rusting, long life drive cap that fits over the top of a fibreglass post to prevent damage during installation
Set of 1x10mm and 1x13mm Driver Cap.



008479	Set 10+13mm	☞ = 1
---------------	-------------	-------

Quattro post



Very sturdy, lightweight spring steel post with 4 removable insulators. Maximum fence height 87.5cm. The 10cm double pointed foot makes it easy to install. White insulated coating for maximum visibility and to avoid shorting problems.



064253	White - 1,00m	☞ = 10
067513	Insulator for Quattro post	☞ = 10



Deer post plastic



Simple solid post for mobile fences to 1.50 m (# 063475) or 1.80 m (# 063482). Wire clips # 063499 to assemble at any desired height. Top insulator is removable so clips can easily be confirmed.



063475	Black - 19mm - 1,70m	☞ = 10
063482	Black - 19mm - 2,00m	☞ = 10
063499	Clips for Deer post 19mm	☞ = 25

Garden/Pond post



Compact, curved plastic post for mobile fences for deterring herons. Ideal for use near a pond. With curve as extra protection against animals leaning over and overhanging plants. For use in combination with plastic wire. Easy to fit. Maximum fence height: 51cm. Product warranty: 2 years.



065035	Black - 0,50m	☞ = 5
---------------	---------------	-------

Tumble wheel



One person can move a whole fence within a matter of minutes using the tumble wheels. The strip grazing system reduces the grazing cycles and increases the yield. Ask your dealer for more information. Maximum fence height: 0.78m.

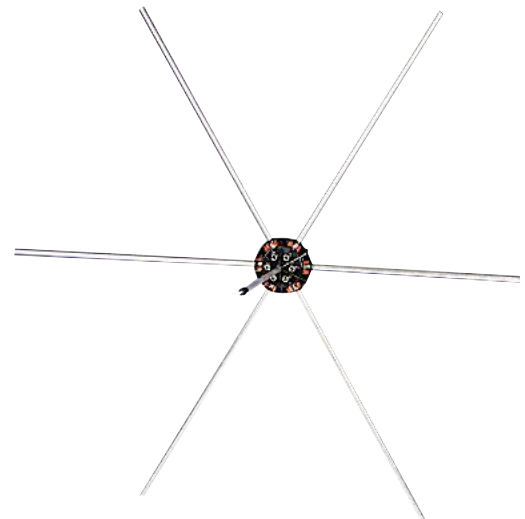

YouTube TUMBLE WHEEL

056388	Tumble wheel	☞ = 5
---------------	--------------	-------





GALLAGHER WOLF FENCING

Wolves are back after an absence of 150 years and farmers fear for their livestock. Over the past months there have been several reports of farmers who came across dead animals that are likely to have been the work of wolves. Farmers receive partial compensation for the damage and the advice is to protect cattle, and sheep in particular, against wolves. Gallagher offers a number of special wolf-fencing concepts and will advise you without obligation; for more information please visit our website or contact us for customised advice.

GALLAGHER'S ADVICE FOR PORTABLE WOLF FENCING

A - Wolf netting 1.20m plus in

Complete netting, all-in-one solution for wolf fencing. The netting is 50 metres long and 1.20m high. In total there are 14 posts with a double pin to ensure it stays strong. The bottom wire is reinforced, which extends its lifespan. This special wolf netting is a plus-minus system, meaning that the conductors have alternating plus and minus wires. If a wolf comes into contact with 2 wires at the same time, the animal receives a strong shock and that is how the system keeps wolves out. The advantage is that it is very easy to put up and take down; extremely suitable for flocks that are moved regularly.

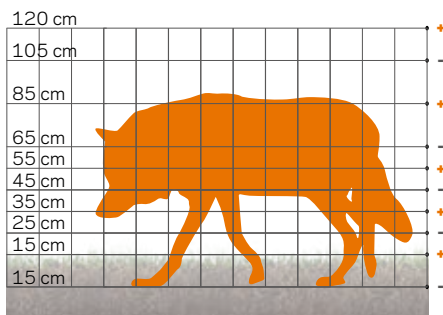

B - Smartfence with Fox light

This unique Gallagher fencing concept is for sheep and goats, but also works to keep wolves out. This all-in-1 system comprises reels, wires and posts. You pull out the fencing as easy as a tape measure. Quick, easy and convenient to put up and take down. Typical for Gallagher and unique. The wire distances from the ground: 15cm - 30cm - 50cm - 70cm and optional 90cm. When you use this solution to keep wolves out, we recommend you use one fox light per Smartfence, as the random light signals frighten off the wolves at night. With 1 Smartfence you can fence off 100 linear metres.

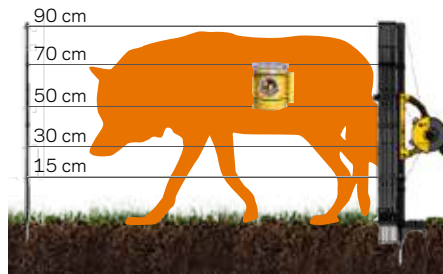

C - Portable Gallagher system

The most effective system for keeping wolves out is permanent fencing, but portable 5-wire fencing is the next best option. Gallagher has a unique solution that consists of blue plastic posts, blue wire and a reel system. The blue plastic posts are typical Gallagher and are easy to carry - as many as 50 in one hand! The blue wire is of excellent quality and has extremely good conductivity. The 4-wire reel system ensures convenience when the wires are unwound or wound back on. We recommend signal tape (no current) as top wire or 12.5mm blue electric tape for even more security.

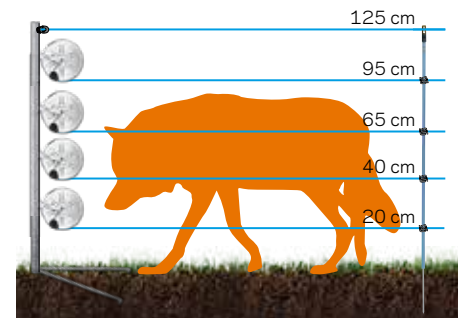

GALLAGHER'S ADVICE FOR PERMANENT WOLF FENCING

To make your permanent fencing suitable for keeping out wolves, Gallagher recommends permanent High Tensile fencing, which has proven to be safe against wolves in Germany for example.

The unique Gallagher post with a fence height of 1.35m (item no 742212) is ideal for permanent wolf fencing. This flexible and durable post fits in with any landscape and can be inserted without heavy tools. Comes with convenient clips for fixing the wires at the right heights. With a 10-year Gallagher warranty. We would be pleased to provide a quotation without obligation.

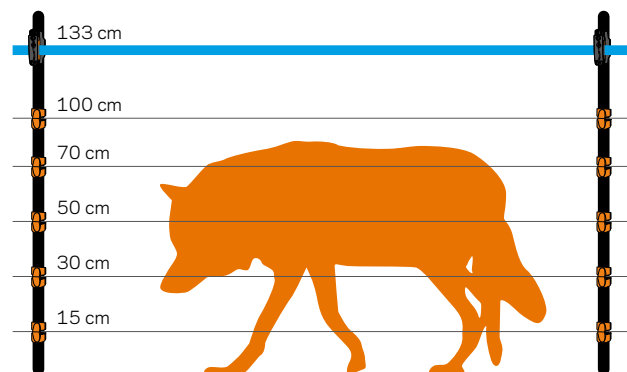

Tip: if you would like to be completely sure? Gallagher recommends double fencing, as this creates an additional barrier. Suitable for isolated areas.

Visit www.gallagher.eu for even more information about wolf fencing



HOW DO I INSTALL MY FENCING?

For properly operating permanent fencing you are looking for durable materials that you can use for many years. It is equally important to make sure this permanent fencing is erected properly. We are pleased to explain the basic principles of how to build permanent fencing. For more comprehensive information, please visit www.gallagher.eu

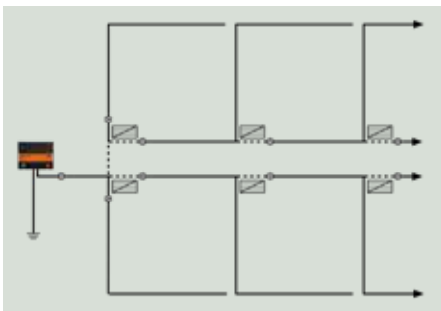

1. Prepare a plan



2. Determine the correct wire height (p. 79)



3. Put up the corner posts



4. Put up the intermediate posts



5. Tension the fencing



6. Fit the energizer and earthing



WIRE HEIGHTS

The height of the wire and the number of wires needed depends on the type of animal. Please find below our advice per type of animal.

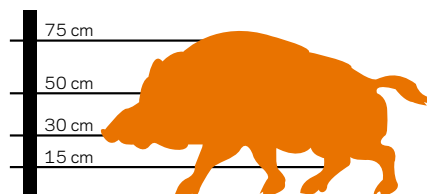
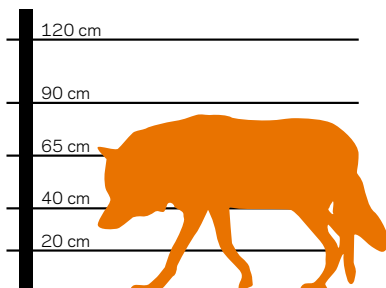
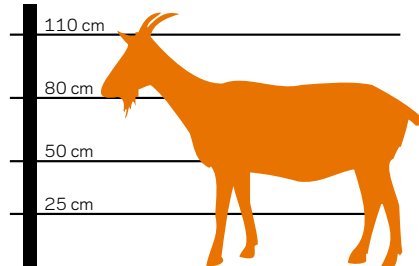
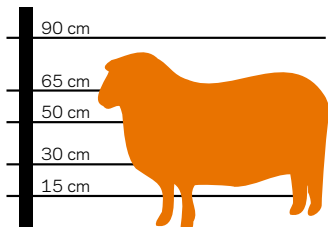
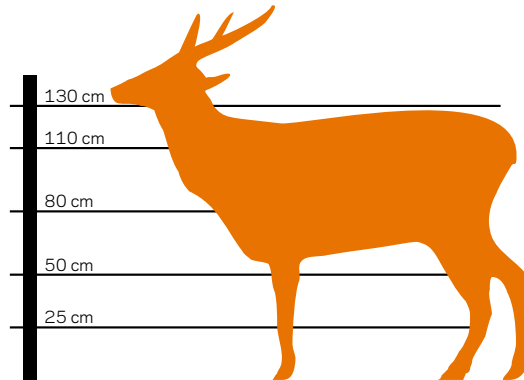
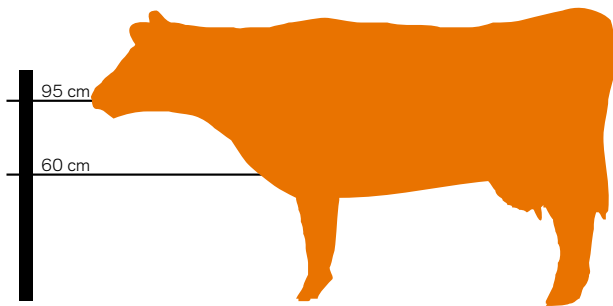
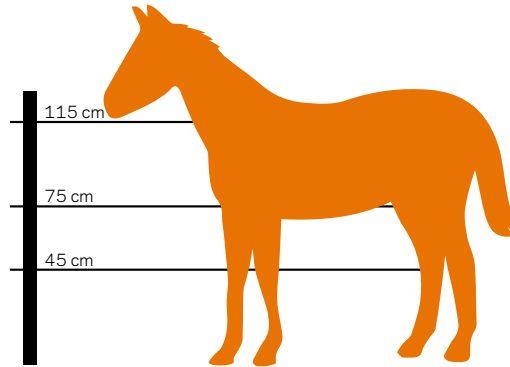
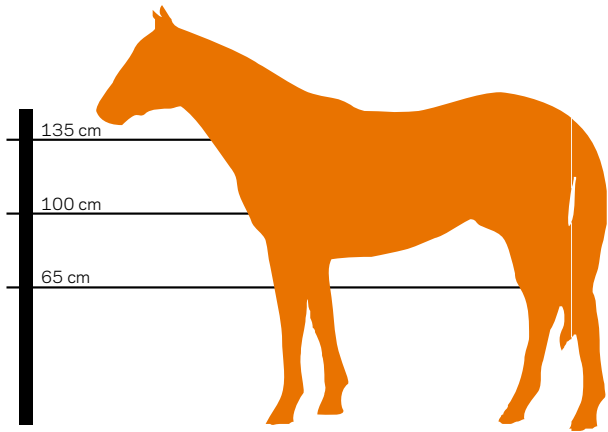



PREPARE FOR THE GRAZING SEASON, DO THE GALLAGHER CHECK!

We know from experience that a well-fitted Gallagher electric fence can last for as long as 30 years. We have developed the Gallagher Check to help you extend your electric fence's life - by regularly inspecting the fence, and doing a bit of maintenance when necessary.



1. Check your electric fence energizer



2. Check the voltage on your fence



3. Check your fencing



4. Check your earthing

It goes without saying that all these steps are explained in detail in the Gallagher Check video. This is available at www.gallagher.eu or our YouTube channel.



Go to www.gallagher.eu
for even more installation advice

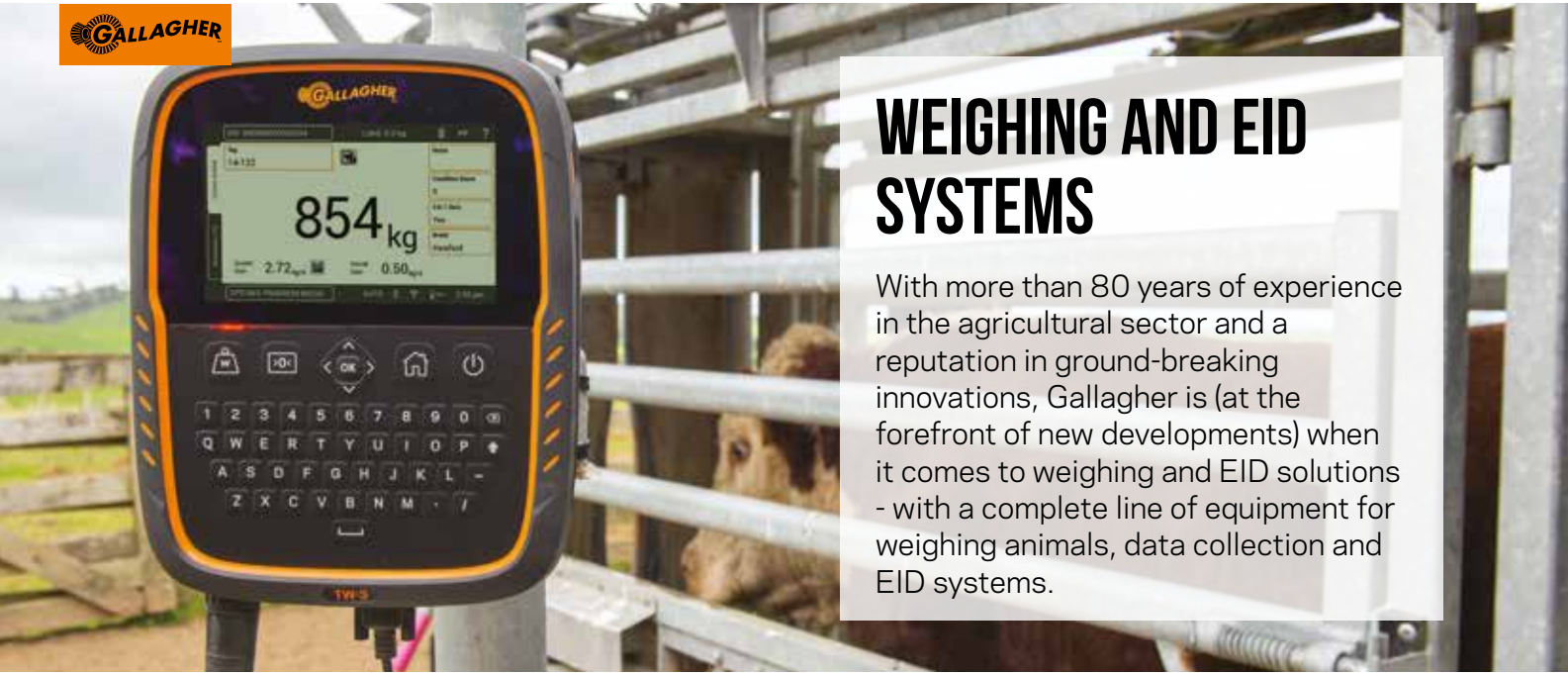

WEIGHING AND EID SYSTEMS

With more than 80 years of experience in the agricultural sector and a reputation in ground-breaking innovations, Gallagher is (at the forefront of new developments) when it comes to weighing and EID solutions - with a complete line of equipment for weighing animals, data collection and EID systems.

The revolutionary TWR-1 and TWR-5 are making the entire Weighing and EID system faster and simpler than ever before.

A market-first integrated EID reader simplifies the weighing process, making animal data collection easier.



260600	Weigh scale TWR-5	☞ = 1	2.50	9.00
026022	Weigh scale TWR-1	☞ = 1	2.50	9.00

- Record treatments on the spot
- Market leading touch screen technology
- On board help, 24/7
- Animal data analysis on device
- Animal notes and note alerts
- Comprehensive life data and traits
- Ultimate user experience
- Draft by weight, weight gain or by ID List
- Tough, rugged exterior





TW-3 and TW-1, the new Gallagher Touch Weigh Scale range makes weighing and data management easier than ever before.

Manage your animal weights and weight gain all on an easy to use, fully intuitive touch screen.



026039	Weigh scale TW-3	☞ = 1	5.83	9.00
026015	Weigh scale TW-1	☞ = 1	2.50	9.00



Weigh scale W310



Entry level automatic weigh scale. Same functionality as W210 + statistics + printer option (serial port).



013053	Weigh scale W310	☞ = 1
--------	------------------	-------

Weigh scale W110



Digital weigh scale, entry level model.



010205	Weigh scale W110	☞ = 1
--------	------------------	-------



SmartReader HR5



Portable Hand Held EID Tag Reader and data collection. High performance readers provide a super-fast read of both HDX and FDX-B tags, and with an ergonomic and hard wearing design they are the perfect tool for portable EID data collection. With its large colour screen and alpha numeric keypad, the HR5 is the most powerful portable data collection and editing platform available providing flexibility right there in the yard. Farmers can record, edit and customise data against EID records immediately without needing to set it up in the office first.

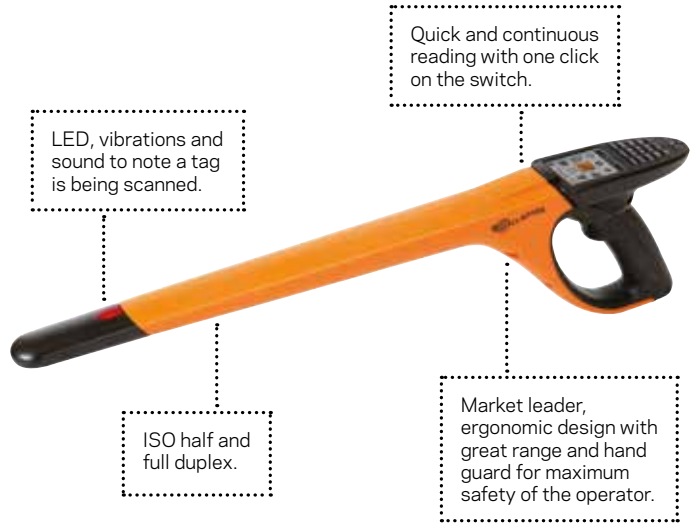

033037	SmartReader HR5	☎ = 1	0.83	9.00
--------	-----------------	-------	------	------



SmartReader HR4



Portable Hand Held EID Tag Reader and data collection. High performance readers provide a super-fast read of both HDX and FDX-B tags, and with an ergonomic and hard wearing design they are the perfect tool for portable EID data collection. Easy recording of pre-defined animal data against EID tag numbers.



068944	SmartReader HR4	☎ = 1		
--------	-----------------	-------	--	--



Combo package



The ultimate combination of Gallagher products to weigh your animals individually and edit and analyze data.



072712	HR5+W310+BT-dongle	 = 1	7.50	7.00
--------	--------------------	---	------	------

Quickweigh kit 600/W210



Easy and simple weighing system for cattle, sheep or horses. Consists of weigh scale W210 and loadbars 2000kg, 600mm



054053	W210 Loadbar set	 = 1	7.50	9.00
--------	------------------	---	------	------

Sheep Auto Drafter



Fully automated weighing, drafting and identification system for sheep. Very light and quiet composite sheep crate with integrated load cells and antenna panels. Includes the main weighing unit and a 3-way drafting unit. Weigh scale and EID reader not included.



057149	Sheep Auto Drafter	 = 1	7.50	9.00
--------	--------------------	---	------	------

For all our weighing and identification products and more information, please visit www.gallagher.eu





0-9			
12V 7,2Ah Battery S200, S400	22	EuroNetz Rabbit netting/Hobby netting	51
12V Battery	34	EuroNetz repair set	53
12V Optima Yellowtop	35	EuroNetz Sheep netting	52
12V SLA Battery	34	EuroNetz Turbo netting	53
20W Solarpanel + Bracket	19	EuroNetz Wild boar netting	51
40W Solarpanel + Bracket	19	EuroNetz Wolf netting	50
4W assist kit for B40/B50	24		
6V 10Ah Battery S40	23	F	
6V 4Ah Battery S10, S16, S20	23	Farmer pliers	69
6V Battery for FoxlightS	38	Fault Finder	40
6V Round Alkaline battery	34	Fence Insulator for pos/neg system	59
6W assist kit	24, 27	Fence Volt Meter	40
9V Powerpack Alkaline battery	34	Fibreglass Driver Caps	76
		Fibreglass post	76
B		Flashlight	13
B10	29	Flood gate controller	38
B100	28	FoxlightS	38
B11	29		
B20	29	G	
B200	27	Gallagher pliers	69
B200+6W solar assist	27	Gallagher Screws	70
B300	27	Gallagher Solarbox	39
B35	28	Garden & Pond kit B10	36
B40	7, 28	Garden & Pond kit M10	36
B40+4W solar assist	28	Garden/Pond post	77
B50	28	Gate handle	66
B60	28	Gate handle anchor	66
Batt-Latch Gate Release Timer	63	Geared reel 500m	68
Battery Charger CTEK	34		
Battery S100	23	H	
Bentonite	67	Handle for Screw-in Tie Down	6
		Heron kit M10	37
C		High Strain insulator Kit with stainless steel rope	56
Claw Insulator concrete	56	High Tensile	42
Click-on insulator	60	Hobby post	75
Clip Fibreglass post 10mm	60	Horse kit B60	36
Clip lock strainer	62	Horse post	75
Clip stainless steel	60	HR5+W310+BT-dongle	85
Clips for Insultimber/Ecopost	57		
Combo package	85	I	
Compression gate handle	66	i Series Alarm System	13
Corner insulator Extra High Voltage	57	i Series Energizer Controller	13
Crocodile clip	39	i Series Fence Monitor	13
Cut out switch	38	i Series Remote Controller	13
		i Series SMS Controller	13
D		i Series WiFi Gateway	11, 13
Deer post plastic	77	Insulated End Strainer	62
Drill chuck Basic	70	Insulated Line Post 0,95m	6, 72
Drill chuck Pro	70	Insulated Line Post 1,35m	6, 72
Drive thru Electro gate	63	Insulated Line Post 1,50m	6, 72
Dual Purpose Portable handle	65	Insulated Line Post Dropper	6, 72
		Insulated Portable handle	65
E		Insultimber (FSC®)	71
Earth stake	67	Inverter 12V/230V	13
Earth Stake Stand for B20/B35	28		
Earthing accessories	67	J	
Eco post	71	Joint clamp	61
EconomyLine rope	44	Joint clamp angle	61
Econoreel 500m	68		
Elastic rope gate set	64	K	
Elastic rope gate set / 2 gate handles	64	Knife Cut-Off Switch	38
Electric fence Keyring Beeper	40		
Electrified steel gate	63	L	
ElectroMax wire	42	Large geared reel 1200m	69
Energizer and Battery Box	39	Lead out cable	67
Equifence	41	Lead out cable XL	67
EuroNetz Combo netting	52	Lead set	39
EuroNetz Gate for electric netting	51	Lightning diverter	38
EuroNetz Goat netting	51	Line Post Lifter Adapter	6, 73
EuroNetz Poultry netting	51	Line Post Pilot	6, 73
		Line Post Rammer	6, 73
		Live fence indicator	40
		Live Tip offset insulator steel post 16cm	59
		Live Tip offset insulator wood 16cm	59
		M	
		M120	17
		M1400	14, 15
		M160	17
		M1800i	12
		M2800i excl. accessories	7, 12
		M2800i incl. accessories	12
		M350	5, 14, 16
		M50	17
		M5000i	4, 11
		M550	14, 16
		M650	5, 14, 16
		M950	14, 15
		MB series 12V Battery Backup system	13, 20
		MB1000	20
		MB150	5, 14, 20
		MB1800i	20
		MB2800i	20
		MB300	5, 14, 20
		MBS200	5, 19
		MBS400	5, 19
		MBS800	5, 18
		Mount Solar post S10, S16, S20	23
		Mounting bracket 40/60mm	60
		Multi reel connector set	69
		Multi strand gate kit	63
		N	
		Neontester	40
		O	
		Offset bolt-on insulator 20cm/M6	60
		Offset Chainlink Insulator cainlink 30cm	60
		Offset Pigtail insulator wood 17,5cm	59
		Offset Pinlock Insulator wire 30cm	60
		Offset screw-in insulator 20cm	59
		Offset screw-in insulator wood 10cm	59
		P	
		Pigtail post	75
		Plastic post	76
		Porcelain corner insulator	57
		Porcelain strain/corner insulator	57
		Post holer 75mm	70
		Poultry kit B60	36
		PowerLine rope	44
		PowerLine tape	48
		PowerLine tape insulator	57
		Q	
		Quattro post	76
		R	
		Rammer	70, 73
		Reel 200m	68
		Reel 400m	68
		Reel/Termination post	69
		Retractable auto reel	65
		Ring Top post	32, 74
		Roller bolt-on insulator	57
		Roller screw-in insulator	57
		Rope connector	61
		Rope connector with wingnut	61
		Rope tensioner	62
		S	
		S10 incl. battery	23



S100 incl. battery	23
S16 incl. battery	23
S20 incl. battery and mount	23
S200 incl. batteries	22
S220	24
S230	24
S40 incl. battery	23
S400 incl. batteries	22
Screw-in Insulator Promopack	55
Screw-in insulator super in bucket (175)	55
Screw-in insulator wood	56
Screw-in insulator wood small	56
Screw-in Tie Down	6, 70, 73
Screw-on rod insulator open version	60
Security kit	38
Sheep Auto Drafter	85
Siren	13
Sleeve for Line Post Rammer	6, 73
SmartFence 2.0	32, 54
SmartReader HR4	84
SmartReader HR5	84
SMS fence alarm	40
SMS remote control (GSM)	13
SnailFence kit M10	37
Soft touch gate handle	65
Solar assist kit	24
Solar kit + Bracket	19
Solar panel	25
Solar panel bracket	25
Solar panel regulator	25
Spring gate set	65
Spring steel pigtail post	76
Spring steel post	76
Stand for S200 and S400	22
Starter kit M10	37
Strain insulator S	56
Strain insulator S reinforced	57
Stranded wire	43

T

Tape connector	62
Tape joiner	61, 62
Tension spring	62
Top mount double end Ring Top offset 80cm	59
Triple Geared Reel Stand pre-installed	69
Tumble wheel	33, 77
TurboLine Blue Polywire	47
TurboLine corner/strain insulator	58
TurboLine Horse corner/strain insulator	58
TurboLine Horse insulator	58
TurboLine Line Post tape clip	6, 58, 72
TurboLine rope	45
TurboLine tape	48, 49
TurboLine tape insulator	58
TurboStar tape	49

U

Universal post Lifter	6, 70, 73
-----------------------	-----------

V

Vandal proof box	39
Vario post / Heavy duty tread in post	75
Vidoflex 12 TurboLine	47
Vidoflex 3 PowerLine	46
Vidoflex 6 PowerLine	46
Vidoflex 9 TurboLine Plus	46
Vidoflex connector	61

W

W-insulator Small	56
W-insulator Super	56

W210 Loadbar set	85
Warning sign	40
Weigh scale TW-1	83
Weigh scale TW-3	83
Weigh scale TWR-1	82
Weigh scale TWR-5	82
Weigh scale W110	83
Weigh scale W310	83
Wire clip insulator for Line Post	6, 56, 72
Wire dispenser	69
Wire tensioner	62, 70
Wire twister	69
Wolf fencing	78

X

XDI bolt-on insulator M6x23mm metal	55
XDI offset bolt-on insulator metal 20cm/M6	58
XDI offset screw-in insulator wood 10cm	58
XDI offset screw-in insulator wood 18cm	59
XDI offset screw-in insulator wood bended 18cm	59
XDI ring insulator	33
XDI screw-in insulator wood	55

Z

Zinc-alu-mag wire	42, 43
-------------------	--------



WE KEEP YOU INFORMED ONLINE!

ORDER NOW ONLINE

It is easy to order your products from our website and pick it up at your preferred dealer. You can find our entire range on the website. If you are not sure which components you need for your fencing please consult your dealer or contact Gallagher. We are all pleased to give you customised advice!

www.gallagher.eu

SUBSCRIBE TO OUR YOUTUBE CHANNEL

Discover how you can check your Gallagher fence or install an energizer. It also has all the information about our latest products. All in easy and short videos. Subscribe quickly and stay up to date!

www.youtube.com/GallagherEuropeBV

Your Gallagher dealer:

Important information! For all promo's available while stock lasts.

Colour and appearances may slightly differ to those of the actual items.



8 713235 061631

1133EXP © 2019